

The Kyushu Electric Power CSR Report 2010

CORPORATE SOCIAL RESPONSIBILITY REPORT



Enlighten Our Future

Towards a comfortable
and environment-friendly
lifestyle today and
for generations to come



Editorial Policy

- This report focuses on particularly important information for stakeholders.
- Our website provides a more detailed web-book version that reflects GRI Sustainability Reporting Guidelines. [http://www.kyuden.co.jp/csr_index/]

2009 Edition

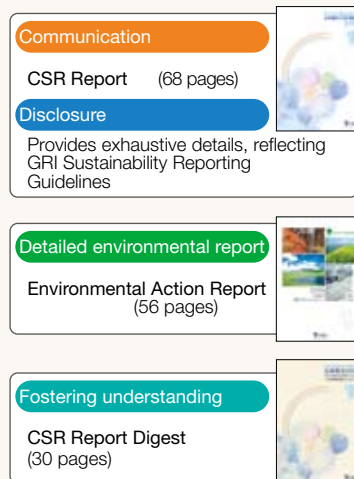

2010 Edition

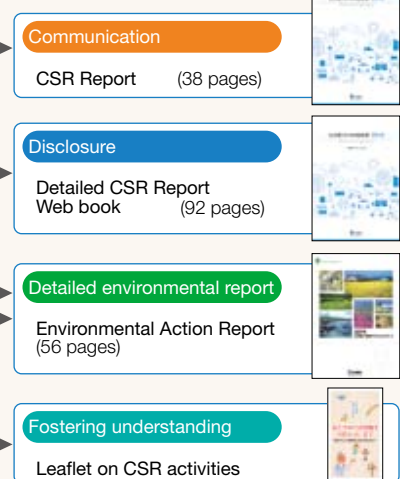

Kyushu Electric Power CSR Report 2010

CONTENTS

Editorial Policy 1
 Contents 2
 Top Management's Message 3
 Management Philosophy 5

Focus One
Toward a Low-Carbon Society

Focus Two
Maintaining Our Safety-First Principle

Operational Management 15
CSR Management 16
 CSR Management
 Results of the Questionnaire Survey about the Japanese Version of the 2009 CSR Report
 FY2010 Group CSR Action Plan
Compliance Management 17
 Compliance Initiatives
 Ensuring Robust Information Security and Personal Information Protection
Improving Disclosure 19
 Boosting Public Relations Responsiveness to Ensure Swift and Proper Disclosure
 Better Communicating Disaster and Emergency Information
 Disseminating Nuclear Power Information
 Investor Relations Program

Environmental Management 21
 Tackling Global Environmental Issues
 Creating a Recycling-Oriented Society
 Preserving the Environment
 Working with Society
 Pursuing Environmental Management
Respecting Human Rights and Caring for Employees 23
 Respecting Human Rights
 Fostering Work-Life Balance and Creating Work Environments that Foster Diversity
 Improving Employee Morale and Skills
Maintaining Our Safety-First Principle 25
 Ensuring Nuclear Power Safety
 Maintaining Occupational Safety and Health
Community Contributions 27
 Deploying Social Initiatives that Reflect Community Feedback
 Fostering the Young
 Initiatives through Business Activities
Business Overview 29
 Looking Ahead to Ensure Stable Power Supplies
 Providing High-Value-Added Services that Balance Comfort and Environmental Concerns
 Overseas Operations
Financial Highlights 34
 Overview of FY2009 Results
 Management Efficiency
Third-Party Assessments 35
PR Facilities 37
Harnessing Group Management Resources to Cultivate Businesses 38
Glossary (Appendix)



Glossary terms are located at the bottom of each page.

Top Five Stakeholder Concerns

- Ensuring nuclear power safety — 91.0%
- Efforts to reach zero-accident goals — 88.8%
- Suppressing greenhouse gas emissions — 87.9%
- Long-term energy outlook — 87.6%
- Efforts to ensure product and service safety — 87.2%

■ These areas were of the greatest concern to the 1,747 stakeholders who responded to our August 2009 survey of the 2009 CSR Report.

- **Report Scope**
 Kyushu Electric Power Co., Inc., and Group companies
- **Period Covered**
 April 1, 2009, through March 31, 2010
- **Issue Dates**
 This report: June 2010 Previous report: June 2009 Next report: June 2011
- **Department Producing Report and Contacts:**
 General Affairs Dept., CSR Group,
 Kyushu Electric Power Co., Inc. 1-82, Watanabedori 2-chome,
 Chuo-ku, Fukuoka 810-8720 Japan
 Tel/Fax: 81-92-726-1564 Email: csr@kyuden.co.jp

□ **Disclaimer**

This report covers past and present information about Kyushu Electric Power Co., Inc., and Group companies, as well as future strategies and goals. Such descriptions do not guarantee the achievement of such goals, which are subject to uncertainties and risks. Business activities may change in line with the operating environment.

Fulfilling our mission as a responsible energy supplier to build a sustainable society

Keep fulfilling our mission of contributing to comfortable and environmentally friendly consumer lifestyles

Since its establishment in 1951, Kyushu Electric Power has made safety a top priority in stably supplying the electricity that is essential to the daily lives of customers and community progress. We have coordinated with communities in such areas as daily facility maintenance and inspection, technical development, power source diversification, and operational efficiency initiatives.

While the economy has shown signs of recovery, the outlook remains unclear because of such concerns as deflation and worsening unemployment. We believe that the operating environment will change even more over the longer term because global energy demand is soaring and it is becoming harder to secure energy sources, while global environmental issues are becoming increasingly important.

We formulated our Long-Term Management Vision in March 2009 to respond to dramatic changes in the business climate and meet our facilities requirements as an electric power company in the years ahead. We also established the Medium-Term Management Policy for 2009 to 2011 to realize this vision and address Medium-Term developments.

As a responsible energy business, we will draw on this vision and policy in daily endeavors to provide our customers with services that deliver comfort and are environmentally friendly.

Looking ahead to ensure stable power supplies while tackling global environmental issues

To ensure long-term energy stability and help materialize Japan's goal of becoming a low-carbon society, we have positioned nuclear power as a central source of electricity. We are also proactively deploying solar, wind, and other forms of renewable energy. As part of this approach, we

are developing more efficient facilities while maintaining their predecessors to ensure long-term stability and efficiency.

We ensure that our nuclear operations are safe and stable and pursue proactive disclosure. We are working to complete the No. 3 unit of the Sendai Nuclear Power Station by FY2019, and are engaging in community-based activities to secure local understanding and cooperation for this project. We started pluthermal operations at the No. 3 unit of the Genkai Nuclear Power Station in December 2009, with safety remaining our number one priority. We are increasing the capacity of spent-fuel storage facilities at our nuclear power stations and are looking into building intermediate storage sites.

We will push ahead with measures to accommodate voltage and frequency fluctuations as we increase the use of solar and other renewable energy sources. We will also explore a next-generation power system that can very reliably maintain supplies of high-quality electricity as renewable sources become mainstream.

Contributing to build a sustainable society in Kyushu, Asia and around the world

While driving forward with solar generation, deploying electric cars, and other environmentally friendly business activities, we are collaborating with customers and their communities to develop renewable energy sources that take advantage of local characteristics.

Particularly in Asia, we are taking advantage of our technologies and expertise to cultivate high-efficiency thermal, geothermal, wind power, and other renewable power operations while cultivating energy conservation and environmental consulting services. Such efforts aim to stabilize energy supplies and reduce CO₂ emissions.

We are additionally raising compliance awareness internally and are conducting business fairly to earn community trust.



Reviewing work styles and organizational structure to respond to the needs of people of all ages for the future

We are reviewing our business operations and organizational structure in light of the potential impact of a falling birthrate, an aging population, and a changing employee age composition. While responding to new needs of society and the employees, such as by enhancing work-life balance and encouraging more female involvement in workplaces, we aim to build an organization in which all employees can reach their full potential and optimize job satisfaction, and grow.

Ensuring safety-first principle and building a corporate culture of safety

We have undertaken disaster-prevention initiatives, making safety the basis of our operations. Tragically, an accident during a regular inspection at the Sendai Nuclear Power Station in FY2009 resulted in a worker fatality and several injuries.

We report on the accident and our preventive measures on page 14 of this report. We are committed to preventing a recurrence of such a tragedy, and will work with Group companies, suppliers, and vendors to uphold our safety-first principle by reviewing safety promotion and management systems and enhancing education and training. We will build a corporate culture that prioritizes public and worker safety above everything while ensuring that we maximize the social safety of our facilities.

Strengthening stakeholder engagement

To further reinforce our CSR initiatives, we make efforts to listen to customers and other stakeholders, such as through publication of this report. We intend to reflect feedback in our endeavors. We would like to thank all

who contributed their valuable opinions.

We identified the most important issues based on stakeholders' opinions and presented them in this report. We have decided to communicate more proactively by producing a new leaflet that explains stakeholders' greatest concerns.

We also produced a detailed version of this report to provide a full picture of our CSR initiatives, posting it on our website, so please refer to it.

We aim to further improve our CSR activities through such communications, thinking and acting in tune with communities to build a sustainable society.

We look forward to your feedback.

June, 2010



Toshio Manabe
President

真部利應

Kyushu Electric Power's Mission

“Enlighten Our Future”

Towards a comfortable and environment-friendly lifestyle today
and for generations to come.

To fulfill this mission, we are dedicated to achieving the following 4 goals:

1 Steady and reliable, Earth-friendly energy.

In order for our customers to lead harmonious lives we will provide steady and reliable, Earth-friendly energy, while anticipating global trends and making full use of our advanced technology and abundant experience with energy and the environment.

2 Services that truly satisfy.

We will offer services that place the gaining of trust from the customer as top priority. We would like to listen to the various voices of our customers in order to respond to their needs with services that truly satisfy.

3 In company with Kyushu. And to Asia and the world.

In company with the people of Kyushu, we will work together to take action while thinking of our children's future and of the prosperity of the region. And from there, we will look to Asia and the world.

4 Discovering solutions, and putting them into practice.

We will discover solutions that lead to a better tomorrow through honest, sincere and active discussions, believing in people's potential and mutually respecting personalities, and we will put these solutions into practice.

Kyushu Electric Power Group Management Basic Policy

We at Kyushu Electric Power Group share a basic management policy group-wide which allows for the independence of each company while promoting a common group-wide united management philosophy.

1. Basic Philosophy

Kyushu Electric Power Group contributes to the creation of a comfortable, eco-friendly and sustainable society by supplying a stable supply of electricity and energy to our customers and providing services that enhance the quality of their lifestyle and the entire society.

2. Management Approach

We will discuss and act in cooperation with all the stakeholders involved in our business activities including customers and local society to create a sustainable corporate value.

- We will listen to customers' opinions and sincerely strive to provide high quality products and services that benefit our customers.
- We will pursue fair business activities, take responsible environmental action, and contribute to the community while working toward the creation of a sustainable community and society in collaboration with local communities and society.
- We will conduct fair business transactions with all of our business partners, build mutual trust, and create values together.
- We will establish an organization and operational structure in which all employees can experience growth and satisfaction in their work.
- We will continuously fulfill the needs of society and produce favorable financial results by constantly engaging in activities that bring improvement.

Charter of Conduct

At the Kyushu Electric Power Group, our customers are the focus of our corporate activities. By supplying our customers with energy and related products and services, we sustainably increase our corporate value and grow in harmony with society.

At the same time, we respect human rights both domestically and overseas, and we are developing business operations to contribute to the growth of a comfortable and rich society.

To steadily execute our business activities as stated above, the Kyushu Electric Power Group promotes compliance management based on the following principles under the trust and understanding of society.

1. Improve customer satisfaction

We will plan for improvements in customer satisfaction by providing valuable products / services for customers safely and surely, and thoroughly protect personal data.

2. Honest and fair business activities

We will promote fair, transparent and free competition and sound trade, and effect honesty and fair business activities, for instance, in the maintenance of sound and proper relationships with politics and administrations.

3. Develop a safety first culture

We will foster a safety first culture which prioritizes not only employee safety but also public safety, in addition to measures to improve technology and equipment.

4. Communication activities

We will meet the demands of society by active information disclosure and communication with members of society at large. And, we will immediately and exactly reflect them in our business activities.

5. Promote environmental management

We will promote environmental management through measures concerning global environmental issues, and work to establish a recycling-oriented society.

6. Contribute to local communities and society

Through our business and philanthropic activities, we will cooperate with local communities and society, and contribute to them.

7. Develop an open and fair corporate culture

We will respect the diversity, character and individuality of our employees and guarantee them fair treatment in the training and application of their talents, while providing them with a comfortable and enriching working environment.

8. Coordinate with the global society

We will observe laws and regulations applying to our overseas activities and respect the cultures and customs of other nations, and strive to manage our overseas activities in such a way as to promote and contribute to the development of local communities.

9. Comply with laws

We will comply with all laws and rules, and we will reject all contact with organizations involved in activities in violation of the law or accepted standards of social behavior.

10. Act up to the spirit of this charter and fulfill upper management's responsibility

Upper management must recognize that their duty is to act up to the spirit of this charter, and must take the lead and get an effective internal system ready. Also, they must make this charter widely known to suppliers, after thoroughly educating employees in its spirit.

If a violation of the law or charter occurs, upper management must take the initiative to solve the problem, seeking out the causes and taking immediate and corrective measures and carrying out recurrence preventive measures. Also, disciplinary action should be taken, including against upper management if necessary.



Toward a Low-Carbon Society

Kyushu Electric Power is striving to minimize society's CO₂ emissions from the provision and consumption of electricity.



Nuclear power

◆ Promoting nuclear power

While safely and stably operating nuclear power facilities that do not generate CO₂, we are undertaking the No. 3 unit of the Sendai Nuclear Power Station and other plans.

See pages 9 and 10 for details.



Thermal power

◆ High-efficiency thermal power

We are improving the efficiency of our thermal power plants.

See page 29 for details of high-efficiency thermal power.



Wind power



Geothermal power



Photovoltaic power

◆ Developing and harnessing renewable energy

We are working on wind, solar, geothermal, and other sources of renewable energy.

See pages 11 and 12 for details.

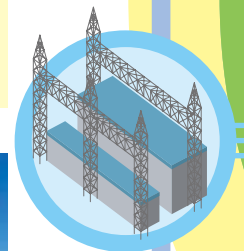

Substation



Reducing CO₂ emissions from transportation

We are developing technologies and infrastructure to promote the use of electric cars, as part of which we are now using such vehicles in our fleet.

See page 31 for our initiatives to promote electric vehicles.

Microgrid system for outlying islands

We are verifying a microgrid system that combines photovoltaic power, small wind power units, and storage batteries to supply to outlying islands that rely mainly on diesel electric generation.

See page 24 of our Environmental Action Report for details on our microgrid system for outlying islands.

Cutting transmission and distribution losses

We are trying to reduce power losses in our transmission and distribution lines between power plants and customers.

See page 12 of our Environmental Action Report for details on how we are reducing transmission and distribution losses.

Helping lower customers' CO₂ emissions

Our Eco Cute water heaters, communications on saving energy, and other efforts are helping customers to lower their CO₂ emissions.

See page 32 for the initiatives to help lower customers' CO₂ emissions.

Conserving energy and resources in offices

Our energy-saving activities have included systematically installing high-efficiency lighting in our offices.

See page 14 of our Environmental Action Report for details on our initiatives to conserve energy and resources in our offices.



Transmission and distribution losses
Eco Cute



Promoting Nuclear Power

Nuclear power is free from operational CO₂ emissions, is important for maintaining energy security and tackling global warming, and is also highly economical.

1. Nuclear Power Today

The first commercial nuclear power station began operating 50 years ago. As of January 2010, the world's 432 such facilities had a combined capacity of around 390 million kilowatts. China, India, and many other countries are constructing or planning nuclear plants in light of new concerns about global warming and energy supply stability.

We operate the Genkai Nuclear Power Station (whose four units generate a total of 3,478,000 kilowatts) in Saga Prefecture and Sendai Nuclear Power Station (whose two units generate a total of 1,780,000 kilowatts) in Kagoshima Prefecture. These facilities account for about 40% of our electricity production. We intend to maintain high nuclear power usage rates by ensuring safe and secure operations, thereby cutting CO₂ emissions.

Impact of CO₂ reductions

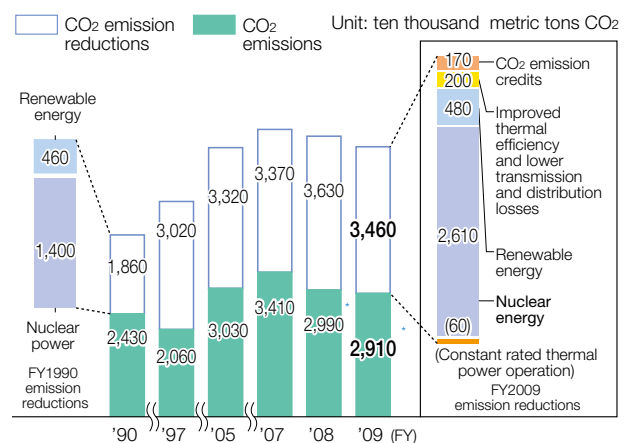

Note: It is impossible to fully calculate reduction impacts for nuclear power and renewable energy because we cannot specify alternative power sources. Our calculations assume that thermal sources (coal, liquefied natural gas, and oil) accounted for all energy generated by nuclear and renewable energy. We have also calculated the reduction impacts by improving thermal efficiency and reducing transmission and distribution losses from a FY1990 baseline. We recalculated data for previous FYs because we reviewed methods for computing reduced transmission and distribution losses for this FY.

* After reflecting CO₂ emission credits

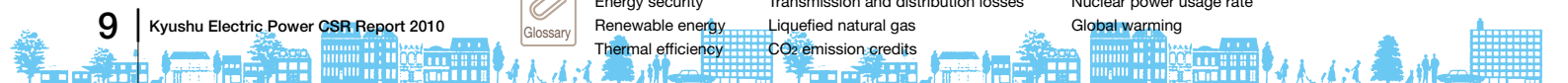

2. Developing No. 3 Unit of Sendai Nuclear Power Station

We plan to complete the construction of the No. 3 unit of the Sendai Nuclear Power Station by FY2019. This is partly to accommodate increasing demand for electricity. Other factors are that it will become more challenging to procure fossil fuels as China, India, and other emerging nations develop, while it is also important to reduce CO₂ emissions in keeping with Japan's commitment to combating global warming.

Since applying to the Kagoshima prefectural governor and Satsuma-Sendai city mayor in January 2009 for permission to build the new unit, we have sought the understanding and support of residents through orientations and visits to 72 local districts.

We consider it vital to consistently undertake community-based initiatives to progress with our construction plan. We will remain fully prepared to

listen to the opinions and requests of residents, reflecting their concerns in this plan.

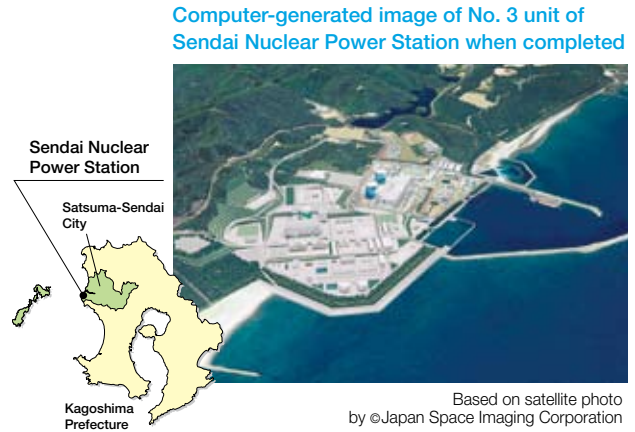

3. Promotion of initiatives to establish nuclear fuel cycle

The nuclear fuel cycle reprocesses spent fuel from nuclear power plants to create new fuel. This is essential for Japan because it has few stable natural sources of energy for the future. The cycle is also necessary for reducing high-level radioactive waste and preventing nuclear proliferation.

We began pluthermal power operations at the No. 3 unit of the Genkai Nuclear Power Station in December 2009. The mixed-oxide fuel is based on reprocessed plutonium.

Storage pools at our nuclear plants temporarily hold spent fuels. We plan to increase the storage capacity of the No. 3 unit of the Genkai Nuclear Power Station.

We will look into building intermediate storage sites to ensure the long-term flexibility of the entire nuclear fuel cycle.

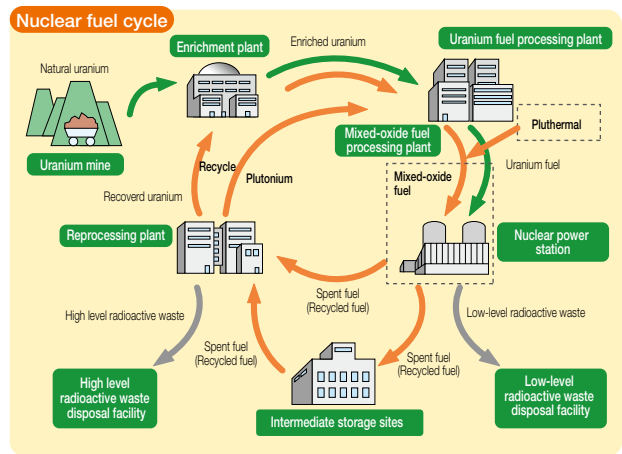

Highlight Framework for Maintaining Nuclear Power Station Safety

Our nuclear power stations employ safety measures based on a multilevel safeguard concept of preventing accidents resulting from abnormal releases of radioactive substances. This concept is based on 1) preventing abnormalities, 2) precluding accidents from occurring or escalating, and 3) stopping abnormal environmental radiation.

Please read Maintaining Our Safety-First Principle on pages 25 and 26 for details of initiatives to ensure nuclear power safety.

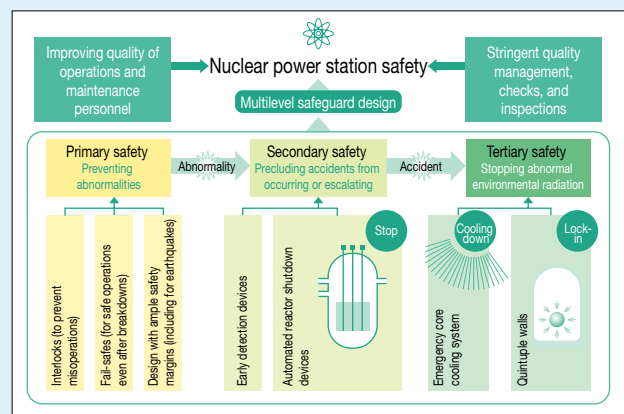

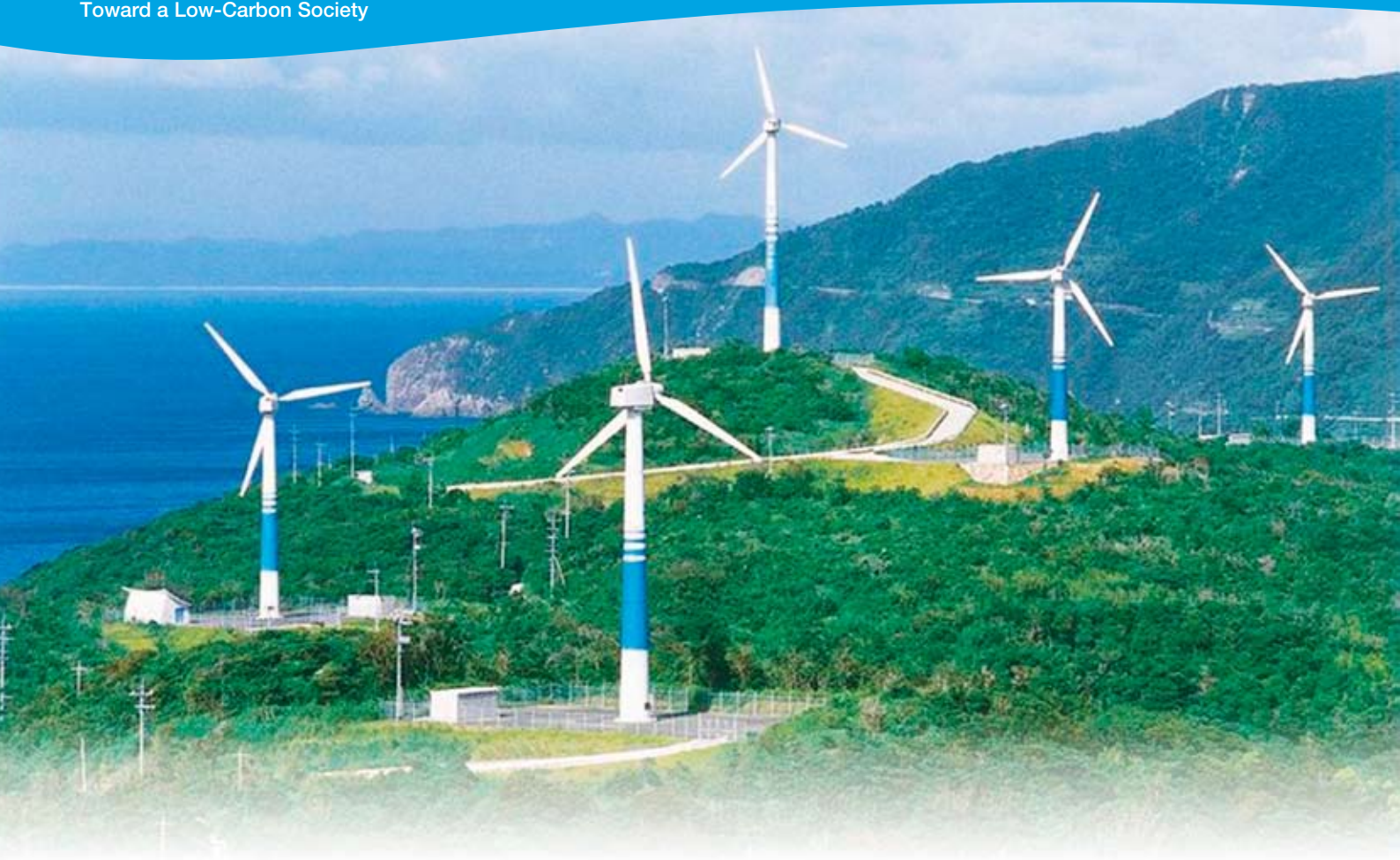

Initiatives to Develop and Harness Renewable Energies

We are effectively developing and deploying such domestic renewable energies as wind, solar, biomass, hydroelectric, and geothermal power, which are also excellent for helping to combat global warming.

We plan to add two million kilowatts of capacity from wind and photovoltaic power generation by FY2017. We are exploring next-generation power systems, notably in terms of enhancing the efficiency of transmission and distribution lines and of supply and demand systems, to prepare for a far greater reliance on distributed renewable energy sources. We have always fulfilled our Renewable Portfolio Standard requirements, satisfying our 890 million kilowatt-hour quota in FY2009.

1. Wind Power

We have already installed 350,000 kilowatts out of a potential one million kilowatts of the interconnection capacity in Kyushu, based on grid impact surveys from power generation data. We will continue to accept wind power interconnections, expanding our use of such energy. We will also conduct wind condition surveys and assessments of promising wind sources while looking into ways of harmonizing facilities with surroundings with a view to developing our own wind power facilities.

▼ Wind and photovoltaic power generation facility deployments

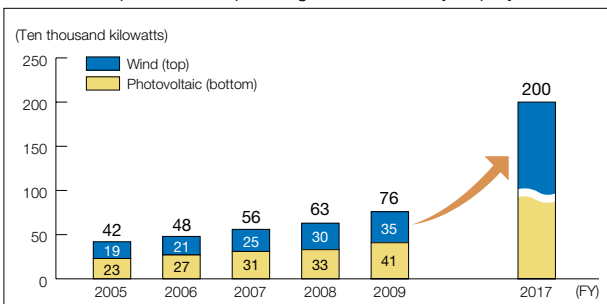

Nagashima Windhill



2. Photovoltaic Power

We are installing photovoltaic power systems at all operational sites and idle power stations. As part of these efforts, we are currently setting up a mega solar power system with a total capacity of 3,000 kilowatts at the idle site of the former Minato Power Station in Omuta, Fukuoka Prefecture. Production is scheduled to start in November 2010.

Outline of Omuta Photovoltaic Power Station

Location:	Shinkomachi, Omuta, Fukuoka Prefecture
Scale:	Output of 3,000 kilowatts Site area about 80,000 square meters
Annual capacity:	Around 3.2 million kilowatt-hours
Annual CO ₂ savings:	About 1,200 metric tons
Operation:	Fully automatic and unmanned



Computer-generated image of Omuta Photovoltaic Power Station

3. Initiatives for Biomass and Waste Power Generation

Group company Miyazaki Biomass Recycle Co., Ltd., generates electricity using poultry droppings. Fukuoka Clean Energy Co., Inc., which we established with Fukuoka city, runs on household waste.

From FY2010 to 2014, we will test mixed power generation with wood biomass with timber offcuts and other unused forestry resources at the Reihoku Power Station in Kumamoto Prefecture.

Wood biomass mixed combustion at Reihoku Power Station

New facilities that incorporate wood chips in coal pulverizer by burning together in boiler.

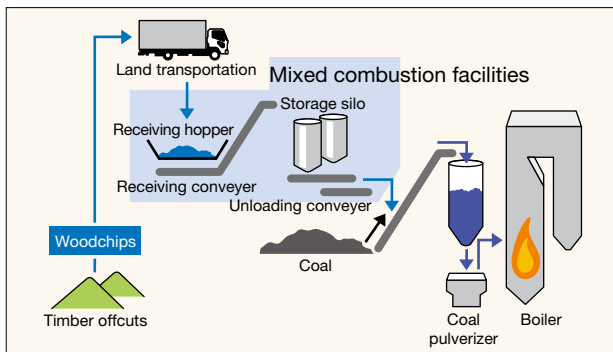

4. Hydroelectric Power

While we will systematically survey and develop hydroelectric power stations based on site economic and environmental considerations, we will develop maintenance flow power generation to discharge dam water to regulate river flows to preserve scenery and river environments.

5. Geothermal Power

Kyushu is blessed with excellent geothermal resources. The combined capacity of our geothermal power stations accounts for about 40% of national output from this energy source. Our facilities have earned considerable recognition. Hatchobaru Binary Power Station won an environmental business award in the eco japan cup 2009. The 110,000-kilowatt Hatchobaru Geothermal Power Station, one of Japan's biggest geothermal facilities, ranked as one of the Shin Ene top 100 best applications of the New Energy.

Compared with other renewable energy sources, geothermal power provides stable supplies year-round. We will continue to survey and collect information for new development opportunities, assessing potential new geothermal sites.



Hatchobaru Geothermal Power Station

6. Next-Generation Power Systems

Massive amounts of distributed solar, wind power, and other renewable energy could eventually be interconnected with transmission and distribution lines. The issue is the supply instability of such sources. To reliably maintain high-quality electricity supplies in the years ahead, we are taking steps to minimize voltage and frequency fluctuations. We are also looking to construct the Kyuden Smart Grid, a next-generation power system that would optimize operations from all power sources, including nuclear, thermal, and renewable energy.

Overview of next-generation power systems

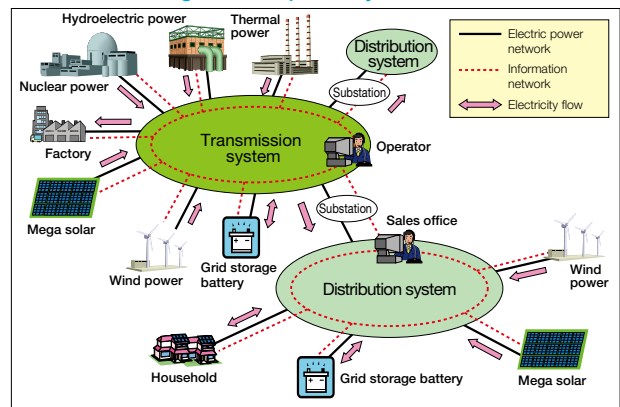



Maintaining Our Safety-First Principle

Safety is our prime priority in all business activities. Tragically, in FY2009 one of our workers was killed during an inspection at one of our power stations. The number of industrial accidents has unfortunately fluctuated in recent years.

Several accidents attributable to human error interrupted the supply of power during the year, although these events thankfully did not result in injury or death.

Many of these accidents resulted from complacency, as successes over the years reduced risk awareness. We consider it necessary to prevent recurrences by bolstering safety awareness in the corporate culture while providing more fail-safes in recognition that people do make mistakes. We

therefore intend to boost risk prediction by drawing on experiences to strengthen safety awareness, sharing accident information, and providing more exposure in training to potentially dangerous situations. At the same time, we will improve facilities to maintain and enhance public safety and supply reliability.

In FY2010, we will establish the Safety Promoters Department to gather relevant information from all business units and help them improve safety management, thus deepening safety awareness in the corporate culture.

Safety will remain our top priority as we improve awareness of this issue in our corporate culture and build safer facilities.

▼ Number of occupational accidents

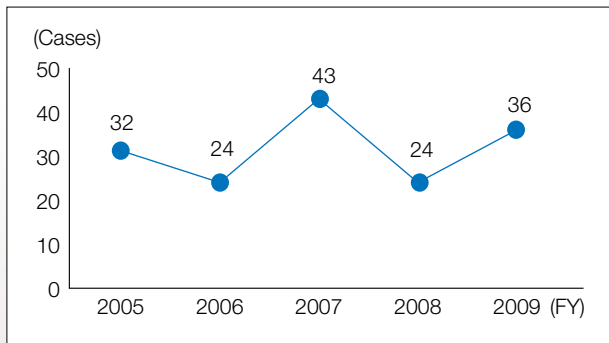

▼ Occupational accidents by category in FY2009

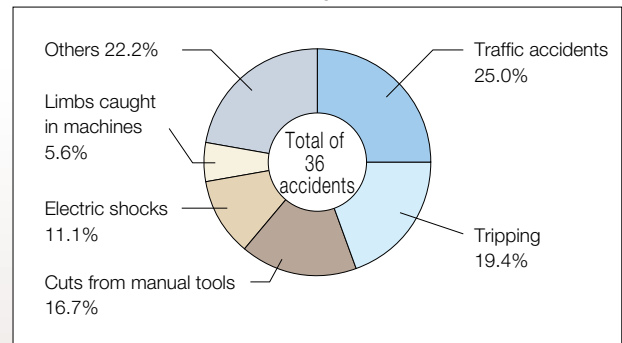

▼ Main power outages caused by human error in FY2009

Date	Number of households affected	Outage times (minutes)	Accident description
04/17/09	250	1	Operated wrong switch when inspecting facility
06/15/09	54	21	During power recovery operation, connected cable while earthing and short-circuit device was still fitted
10/20/09	153	28	Incorrectly transmitted power through wrong high-voltage cable (6-kilovolts) during noninterruptive work
11/16/09	148	11	Cut cable using wrong noninterruptive switching procedure
12/22/09	4,500	5	Mistakenly severed control cable that was still operating during cable removal at substation
01/19/10	7,700	28	Power generator stopped due to misoperation in regular facility inspection during shutdown at internal combustion power plant
01/24/10	1,659	5	Operated wrong switch after replacing power pole

Analyzing and Preventing Recurrence of Fatal Electric Arc Accident during Generating Facility Inspection

In January 2010, one worker was killed and six were injured owing to an electrical arc during outage work as part of a regular facility inspection at the Sendai Nuclear Power Station.

Accident Cause

The accident seems to have stemmed from contact between grounding equipment and a live terminal when the workers were trying to fit an earth wire. This apparently triggered an electrical arc that ignited gas and burned the workers. We assume that several factors combined to cause this accident, including that the workers were insufficiently aware that their job was near a live terminal.

Recurrence Prevention Measures

As we were unable to conduct a full hearing to investigate the above factors, we implemented all possible measures to prevent a recurrence.

■ Clarification of procedures and precautions

- Describe in the operational procedure manual whether participants have confirmed whether or not a job is near

an electricity source and that voltage from both busbar and supply terminals is detected.

- Label to identify supply and busbar terminals.
- For each task, clearly define the scope of tasks requiring power shutdowns to ensure safety.
- It should be clearly written in work rules that power should be completely off in two circuit locations if at all possible. In principle, work near live electrical sources is prohibited. If working near a live terminal, protective covers and other safety measures shall be used.

■ Informing and educating related parties

- Inform related parties about these and other measures.
- Educate related parties about the objectives and importance of electrical inspections and appropriate techniques
- Strengthen hazard prediction activities.

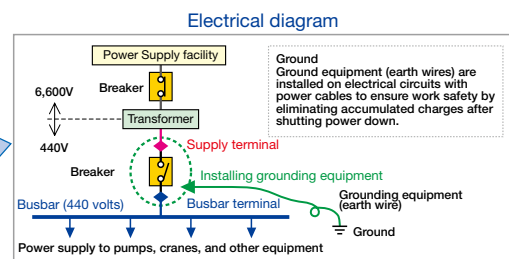
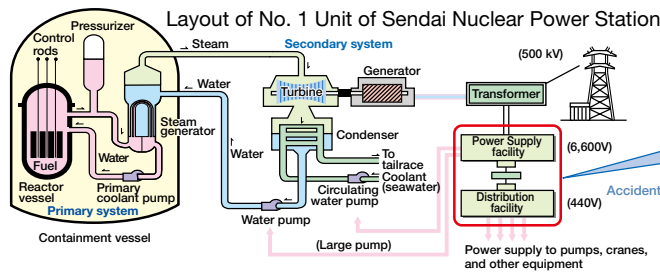

Analyzing and Preventing Recurrence of Breakage of 220 kV Underground Cable

In December 2009, a 220 kV underground cable in Kitakyushu snapped, destroying a manhole cover and damaging the road, nearby houses, and vehicles.

Accident Cause

The accident was attributable to cable insulation slippage because of mechanical and thermal stresses, which reduced dielectric strength. The mechanical stress on the cable was caused by installation in an area where there were large curves on a slope, and the thermal stress stemmed from the cable being used in an environment of extremely large daily fluctuation of power flows.

We concluded that cable broke because voltage overwhelmed the dielectric capacity because the charge accumulated on the cable was retransmitted instead of discharging.

Recurrence Prevention Measures

We took the following steps to prevent a recurrence of cable and manhole cover damage.

■ Proper discharging

- Add discharge confirmation step and operational explanation.
- Improve education and training.
- Add fail-safe function to the computer control system.

■ Diagnose cable deterioration

Identify locations in which insulation could deteriorate because of similar installation and usage conditions, sampling to conduct destructive checks and assess deterioration.

■ Safeguarding entrance hole for workers

To ensure that damage to the manhole cover does not cause damage outside the hole if a similar accident occurs, we will strongly connect the cover and entrance of all oil-filled electric cables by FY2011.

We will cover all 220 kV cables in the manholes with highly inflammable tape to prevent fire from spreading between cables. That is because one cable burnt others nearby and increased the damage.

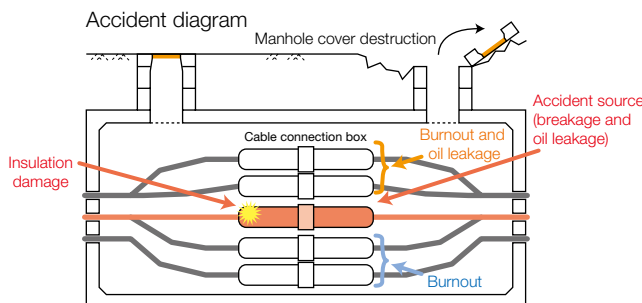

Operational Management

We have accorded top priority to strengthening corporate governance to ensure that our business is in the long-term interest of society, in keeping with our brand message of Enlighten Our Future.

The Board of Directors and the Board of Auditors oversee corporate governance. We have strengthened management supervision by appointing independent external directors while reinforcing cooperation between auditors and our internal auditing organization to improve auditing effectiveness. Directors handle monitoring while executive officers focus on implementation. We undertake ongoing efforts to strengthen oversight and compliance management systems, and formulated our basic corporate governance policy (basic policy of internal controls) to maintain healthy management.

Board of Directors

In principle, this body meets monthly and whenever otherwise necessary to decide on important corporate management matters and monitor implementation.

The Corporate Management Committee considers matters requiring further discussion before Board of Directors makes decisions and decides on important executive issues.

Each division and branch office has an executive officer to accelerate decision making and streamline operations.

Board of Auditors

Auditors attend important gatherings, including those of the Board of Directors. They conduct hearings for all divisions, consolidated subsidiaries, and other business units and otherwise conduct overall audits of the work of the Board of Directors and executive officers.

In principle, the Board of Auditors meets monthly to debate on and make resolutions about reports on important matters relating to laws and ordinances and the articles of incorporation.

The Corporate Audit Office assists this body.

Internal Auditing

We set up an internal auditing body that functions objectively, ensuring that operations are proper and helping to improve management efficiency. The office audits compliance and business operations at all divisions and branch offices.

Staff from this office audit quality assurance systems for safety initiatives at nuclear and thermal power stations and other important facilities.

▼ Corporate governance and CSR promotion structure

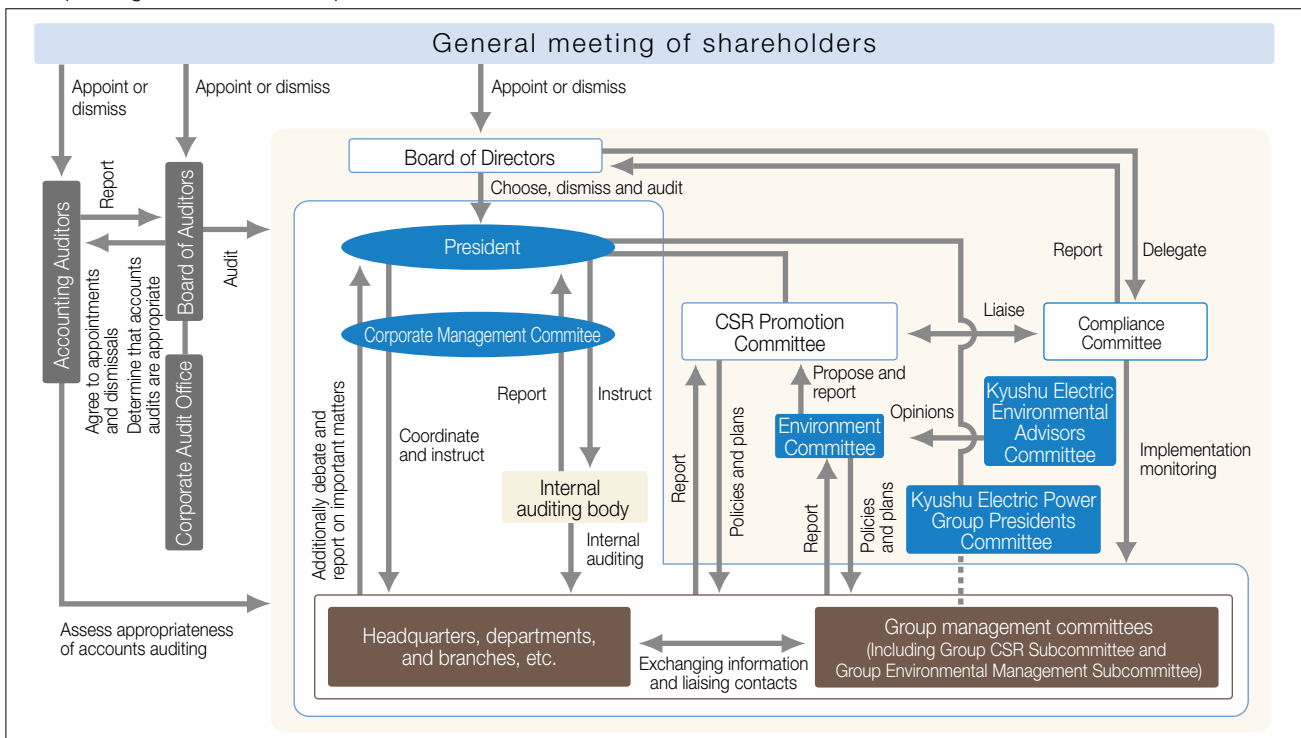

CSR Management

We are building a CSR management cycle that reflects feedback from customers and other stakeholders in our management and operations.

CSR Promotion Committee

We appointed one director to oversee our CSR management structure. The president chairs the CSR Promotion Committee, which formulates our CSR action plans and deliberates on our CSR Report as part of efforts to bolster our initiatives.

Group CSR Promotion Subcommittee

We established this body to foster Groupwide CSR efforts, ensure understanding of our action plans and implement plan-do-check-act (PDCA) initiatives.

Results of the Questionnaire Survey about the Japanese Version of the 2009 CSR Report

- Conducted from June 25, 2009 through May 31, 2010
- Number of responses: 712

1. Evaluations of the Report

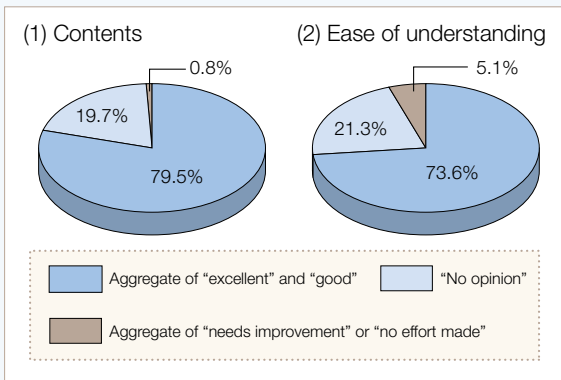

2. Evaluations of the Company's Efforts

Issue	Rating (%)			
	20	40	60	80
Compliance management	83.3			
				15.0
Disclosure	81.4			
				15.9
Environmental management	84.5			
				13.9
Human rights and employee care	78.6			
				19.1
Adherence to safety-first principle	82.8			
				14.3
Community activities	86.1			
				11.3
Overall assessment	89.7			
				8.7

Legend:
 ■ Aggregate of "excellent" and "good"
 ■ "No opinion"
 ■ Aggregate of "needs improvement" and "no effort made"

FY2010 Group CSR Action Plan

Compliance management → P. 17

1. Raising compliance awareness
2. Pursuing fair business activities

Improve disclosure to ensure management transparency → P. 19

1. Boosting public relations responsiveness to ensure swift and proper disclosure
2. Disseminating nuclear power information
3. Conducting investor relations activities

Environmental management → P. 21

1. Tackling global environmental issues
2. Creating a recycling-oriented society
3. Preserving the environment
4. Working with society
5. Pursuing environmental management

Respecting Human Rights and Caring for Employees → P. 23

1. Respecting human rights
2. Fostering work-life balance and creating work environments that foster diversity
3. Improving employee morale and skills

Maintaining safety-first principle → P. 25

1. Maintaining facility safety
2. Ensuring operational safety and mental and physical health
3. Improving safety of products and services, and education about electrical safety

Community contributions → P. 27

1. Engaging in collaborative activities as a good corporate citizen



Compliance Management

To increase trust among customers and the people in its service area, Kyushu Electric Power maintains strict compliance while also operating with transparency and fairness in keeping with its commitment to ethical conduct.

Compliance Initiatives

Compliance Management Structure

We established the Compliance Committee in October 2002 under the oversight of the Board of Directors. The committee appoints the heads of head-office departments, branch offices and business sites as Compliance officers to ensure companywide compliance management, thus raising awareness of issues.

We set up internal and external compliance consulting desks that work as an internal reporting system.

The Group CSR Subcommittee disseminates action plans and provides information to Group companies (see page 16).

Compliance Committee

The president chairs this body, whose members include directors, the chairperson of the Company's labor union committee and three external experts, with auditors attending, to ensure objectivity and transparency.

This committee meets semiannually to deliberate on and propose compliance management policies and responses, and to monitor progress.

Compliance Consultation Desks

We set up compliance consultation desks in February 2003 to prevent or quickly identify legal and ethical violations. In April 2005, we began external counseling services through a law firm.

The rules for setting and running compliance consultation desks mandate complete confidentiality for all users. It is forbidden to treat any user unfavorably for using or making reports through these services.

In FY2009, there were 22 cases in which people sought consultation or reported compliance abuses (see below).

Please note that we maintain a sexual harassment advice desks (see page 23).

Compliance Abuse Consultations and Reports in FY2009

• Doubts about operational practices	10
• Complaints about employee conduct	6
• Consultations about the law and other consultations and queries	6

▼ Compliance Management Structure

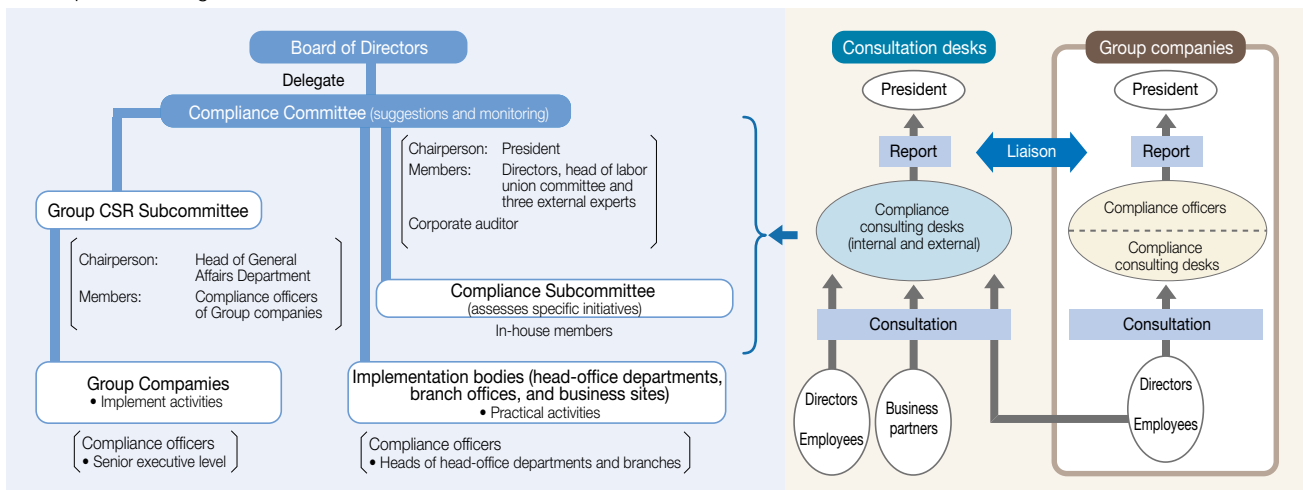

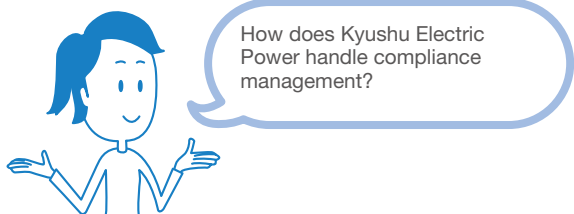

▼ Compliance Consultation Desks

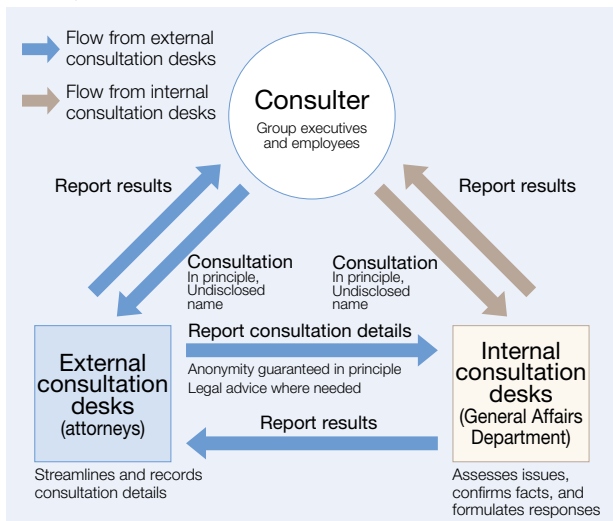

Raising Employee Awareness through Education and Training

We provide ongoing education and training through seminars and e-learning on our Compliance Action Guidelines and departmental action guidelines.

Personnel ratings are another tool for raising compliance awareness. Such assessments encompass corporate ethics and other issues, and whether employees adhere to compliance requirements.

We also provide education and training to Group companies.

Ensuring Robust Information Security and Personal Information Protection

Information Security Management Structure

The president is ultimately responsible for managing information security. Officials from each head office department, business site and group operation oversee security at their respective operations to safeguard internal and personal information.

The Information Security Committee and the Information Security Officers Committee ensure all departments, business offices, group operations companywide properly use PDCA cycles and maintain information security and protect personal information.

Information Leaks and Preventing Recurrences

There were 30 incidents of lost documentation containing personal information in FY2009, including customer meter reading notices and payment slips for utility pole site fees.

The information could have leaked to third parties in all these incidents, which should not have occurred in the first place. We are therefore taking extensive ongoing steps to completely safeguard personal and company information.

▼ Information Security Management Structure

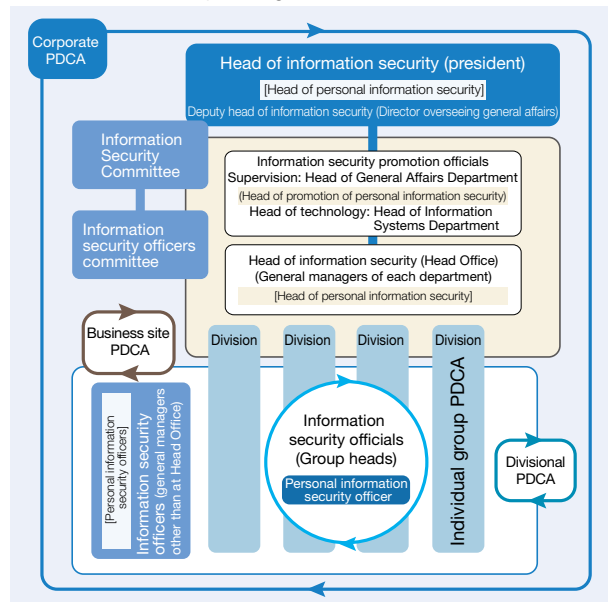

Preventing Recurrences

- Strengthen information handling in keeping with office regulations
- Continuously educate all employees
- Share information, including for Group companies, about example of leaks through our compliance intranet
- Assess external contractors' information security management and request improvements

Improving Disclosure

We properly and swiftly disclose information to keep our operations transparent and to secure the understanding and trust of our customers.

Boosting Public Relations Responsiveness to Ensure Swift and Proper Disclosure

Disclosure Approach

We formulated the Kyushu Electric Power Disclosure Commitment in April 1999 to demonstrate our basic stance on disclosure and maintain transparency and increase public confidence in our business. We accordingly disclose simple, timely, and accurate information at press conferences and on our website, informing about operations or about problems with nuclear or thermal power stations or outages attributable to human error.

Proactively Disclosing Information

We produce an annual plan for proactive communications through press conferences, our website, and brochures. We updated our disclosure rules in February 2009 to ensure speedy and accurate disclosure, especially for accidents, violations of corporate ethics, and other disadvantage information to customers and society if not disclosed.

Holding Regular Presidential and Other Press Conferences

Mass media significantly influences customer views of the Company. We cultivate understanding of our operations, nuclear power, and other areas by holding regular presidential and other press conferences. We disclose site information and hold tours and press briefings to ensure accurate news coverage.



Regular press conferences with president

Actual transmission based on disadvantage information to customers and society if not disclosed.

We held the following press conferences in FY2009.

Main subjects

- Outage attributable to human error
- Breakage of 220 kV underground cable
- Employee fatality and injuries during regular inspection of No. 1 unit of Sendai Nuclear Power Station

	FY2008	FY2009
Outage	5	17
Nuclear power	7	3
Facility problem	1	7
Others	5	5
Total	18	32

Better Communicating Disaster and Emergency Information

We quickly identify and assess the information of blackout and emergencies, such as typhoons and earthquakes. We use this data to handle customer inquiries and disseminate an array of information through the media and our website.

We started a service in 2008 to email information on outages stemming from disasters to customers' preregistered cell phone addresses. In June 2009, we enhanced the service by additionally reporting on the operational conditions of nuclear power stations following large earthquakes.

▼ Sample text of emergency information sent to cell phones

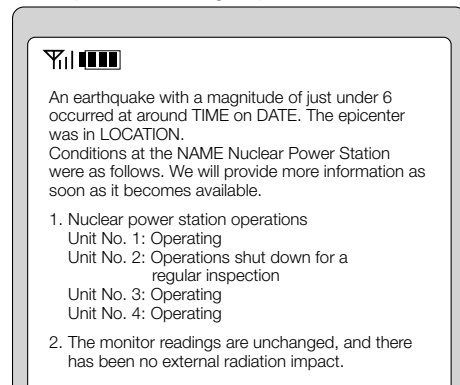

■ Cell phone website: <http://kyuden.jp/>



Tell us about your nuclear power information disclosure.

Our nuclear power stations speedily and accurately disclose information through press conferences and our website, including about minor equipment malfunctions that do not affect safety.



Disseminating Nuclear Power Information

We aim to maintain customer trust and peace of mind by keeping people fully informed about our nuclear power operations speedily and accurately. We appropriately disseminate information to build customer support for our pluthermal project and construction of the No. 3 unit of the Sendai Nuclear Power Station.

Disseminating Nuclear Power Information

We swiftly and accurately disseminate information about nuclear power station operations and problems through press announcements and our website.

Activities to Deepen Understanding of Nuclear Power

We build understanding about nuclear power, and environmental and energy issues by distributing pamphlets, holding energy lectures, providing scientific experiments and guest-run classes for children and organizing nuclear power station tours.

At the same time, we interact with the community in numerous ways, including by talking with local opinion leaders.

We maintain an extensive publicity program which encompasses running commercials in television shows that we sponsor, advertising on newspapers and communicating through the Internet.

Nuclear Power Information Disclosure in FY2009

1 Number of press conferences on nuclear power issues in FY2009: 55

Subjects	Number of conferences
Issues relating to regular inspections of nuclear power stations (notably, the start of regular inspections, reactivation, and returns to normal operations)	11
Pluthermal issues at No. 3 Unit of Genkai Nuclear Power Station	11
Construction plan issues relating to No. 3 Unit of Sendai Nuclear Power Station	6
Earthquake-proof safety of nuclear power stations	2
Issues relating to transporting new and spent fuel to and from nuclear power stations	13
Accidents and other problems	3
Others	9

2 Website information

- Overviews of nuclear power stations
- Operational and regular inspections at nuclear power stations
- Problems at nuclear power stations
- Real time data (on output and radiation)
- Pluthermal information (such as iodine concentration measurements to demonstrate fuel soundness)

3 Disclosure facilities

- Established nuclear information booths at Kyushu Energy Science Center, Genkai Energy Park, and Sendai Nuclear Power Station Exhibition Hall

Investor Relations Program

We formulated our Investor Relations Basic Policy to build trust with and enhance the satisfaction of shareholders and other investors. This policy underpins our investor relations program.

We keep institutional and individual investors and analysts in Japan and abroad well informed about our business activities. Executives speak at investor relations briefings and accompany our investor relations officers on visits to domestic and overseas investors. We also hold regular facilities tours for these stakeholders.

Our website presents materials such as investor briefings and financial and stock information in line with our commitment to proactively disclose the corporate information in an easy-to-understand manner.

We set up a website that allows shareholders to vote on resolutions and provides visual presentations of business reports at general meetings of shareholders. These and other initiatives make it easier for shareholders to participate in such gatherings.



Environmental Management

To help create a sustainable society, we are pursuing Groupwide environmental management to both the business activities and environment.

Tackling Global Environmental Issues

Reducing Greenhouse Gas Emissions

We have undertaken activities in power supply and consumption and in applying the Kyoto Mechanism and as part of steady progress toward creating a low-carbon society.

In FY2009, we reduced our CO₂ emission 800,000 metric tons from a year earlier, to 29.1 million metric tons.

CO₂ emissions from electricity sales volume were 0.348 kg per kWh. We achieved our goal for the second straight year of lowering emissions 20% from FY1990 levels.

Goal

Cut average CO₂ emissions intensity from electricity sales volume for FY2008 through FY2012 by around 20% from 1990 levels (reduce to around 0.348kg-CO₂/kWh)

▼CO₂ emissions kg-CO₂/kWh, results and forecasts for CO₂ emissions kg-CO₂/kWh from electricity sales volume

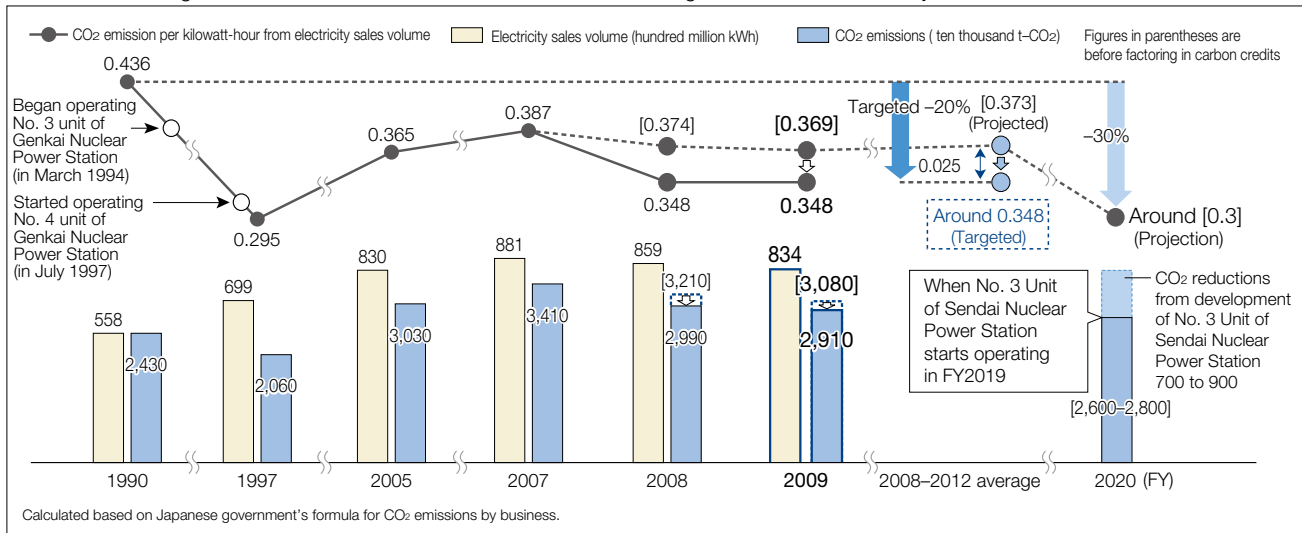

Creating a Recycling-Oriented Society

Undertaking Zero-Waste Emission Activities

Our industrial waste includes coal ash and gypsum from thermal power operations and materials we remove from construction work. We properly manage and treat such waste in keeping with legal requirements, and are practicing the 3Rs (Reduce, Reuse and Recycle) to minimize such waste.

We also properly manage, process, and practice the 3Rs for general waste, including the paper we use in our offices, shellfish from power plants, and driftwood from dams.

▼Quantity of industrial waste generation and recycling rates

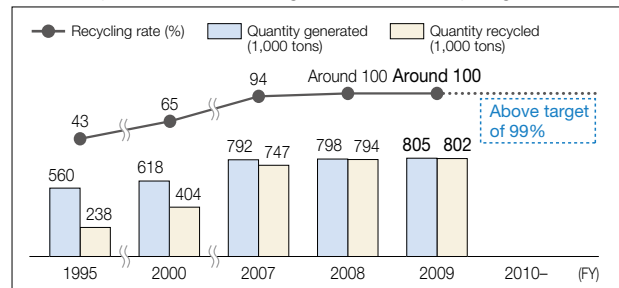

▼General waste from paper and other sources in FY2009

	Amount created (metric tons)	Amount recycled (metric tons)	Recycling rate (%)	Major uses of recycled materials
Paper	1,390	1,390	100	Recycled paper
Shellfish	162	147	91	Fertilizer
Dam driftwood	2,082	2,082	Around 100	Alternative litter



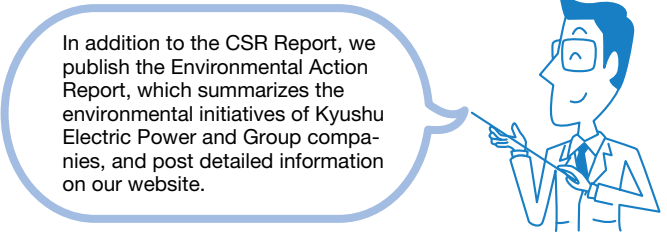
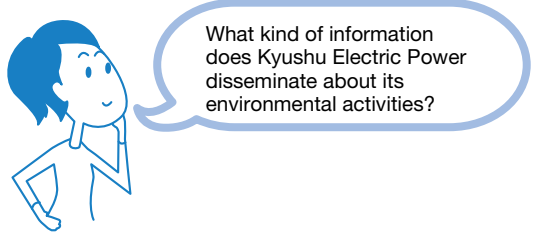

Preserving the Environment

Air Pollution Measures

We have implemented various measures to reduce emissions of sulfur oxides and other pollutants from our thermal power stations.

As a result of appropriate facility operations, our sulfur oxide and nitrogen oxide emissions per unit of electricity generated from our thermal power stations were far below the international standard in FY2009.

▼ Global sulfur oxide and nitrogen oxide emissions per unit of electricity generated from thermal power stations

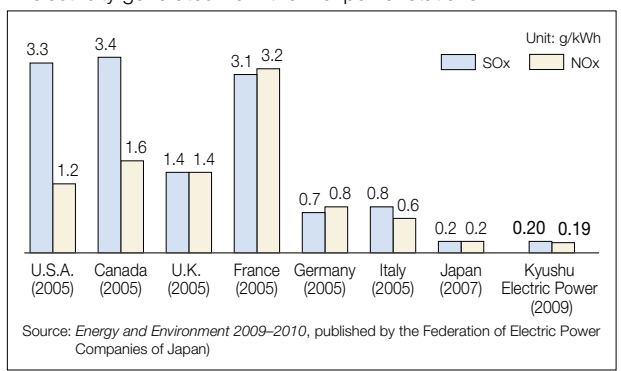

Working with Society

Kyushu Homeland Forestation Program

We commemorated our 50th anniversary in FY2001 by launching the Kyushu Homeland Forestation Program. We are working with regional residents in this initiative to plant one million trees in 10 years.

We promote forestation largely by planting native evergreen oaks that require less upkeep.



Kyushu Homeland Forestation Program at Higata Yoka Park in Saga City, Saga Prefecture

Eco Mothers Activities

We initiated Eco Mothers Activities in FY2003 to help educate children about the environment and provide parents with information so they can enlighten their children at home.

In the past few years, more than 20,000 children and parents have participated in around 300 visits annually. The number of participants exceeded 100,000 in the past seven years.



Eco Mothers Activity at Kasugamachi Kindergarten in Oita City, Oita Prefecture

Pursuing Environmental Management

Environmental Management Systems

All our business sites have created and deployed environmental management systems based on the ISO14001 certification standards to ensure that we consistently comply with environmental requirements and reduce our environmental impact.

Our Environmental Affairs Department seeks ongoing improvements in operational standards for our environmental management systems by providing

operational support for business sites and training for environmental management officers and offices.

Each Group company builds its own environmental management system based on the Group's standard for constructing such systems, which has six construction stages.

Group companies collaborate in environmental management, consistently lowering environmental impact by accurately implementing and effectively applying environmental management systems.

Respecting Human Rights and Caring for Employees

People are fundamental to improving corporate value, and accordingly we provide rewarding and meaningful working environments.

Respecting Human Rights

Enlightening Awareness

We respect human rights and provide education for employees in all Group operations to help build a comfortable and affluent society.

It is equally important for employees to understand human rights and anti-discrimination issues and act correctly. In April 2008, we established policies on these issues to drive ongoing employee education. We hold seminars for all Group operations to maintain and enhance human rights awareness.

About 12,714 employees participated in human rights and anti-discrimination seminars in FY2009.

Addressing Sexual and Power Harassment

Sexual harassment and power harassment disrupt workplaces and prevent people from properly performing their tasks, potentially harming our reputation in society. We therefore seek to enlighten our employees by distributing pamphlets, holding training and seminars, and maintaining internal and external sexual and power harassment counseling services.

Five employees used our sexual and power harassment counseling services in FY2009.

Fostering Work-Life Balance and Creating Work Environments that Foster Diversity

Balancing Work and Private Commitments

We help employees to better balance their work and family commitments, and create an environment that enables them to remain in our employ.

In FY2009, we expanded spouse maternity leave from three days to five and extended the ages of children that our nursing leave program covers from pre-school to the end of third year elementary school.

We increased the number of days for nursing leave

from a uniform five days to 10 days for employees with more than two children, and established the family care leave program in April 2010. We will continue to improve our systems to flexibly accommodate the child and family member care needs of employees.

▼ Child and Family Care Support System Overview and Achievements

Item	Leave	Shorter work hours	Spouse maternity leave for male employees only	Nursing leave
Childcare support	Period Through April after child reaches two years of age System users in FY2009 58 (no men)	Period Until the end of the child's third year elementary school Permissible shortening of hours <ul style="list-style-type: none"> • One, two, or three hours per day • Can set up times to start and finish work in units of 10 minutes Other opportunities Can simultaneously work flextime System users in FY2009 124 (including 1 man)	Five days at time of childbirth System users in FY2009 379	Five days annually for illness and injury of child who has yet to complete third year elementary school. (half-day breaks permissible) System users in FY2009 318 (including 219 men)
Family care support	Period Two years in total (730 days) for the same care receiver System users in FY2009 3 (including 2 men)	Period Until care is no longer needed Permissible shortening of hours <ul style="list-style-type: none"> • One, two or three hours per day • Can set up times to start work in units of 10 minutes Other opportunities Can simultaneously work flextime System users in FY2009 2 (including 1 man)	_____	_____



Is it easy for women and senior citizens to work for Kyushu Electric Power?

We are trying to improve our work environments and systems to ensure job satisfaction for all employees regardless of gender or age.



Initiatives for Female Employees

We undertake comprehensive initiatives to motivate our workforce and create a dynamic corporate culture for all employees, regardless of gender or age. Efforts include helping female employees to build their careers, balance their work and home commitments, and fostering a culture of broader awareness to support these objectives.

In FY2009, we held seminars for managers with female subordinates and informal gatherings for female employees and exchange of opinions with executives from all branches about encouraging greater involvement of female employees.

Try Net Intranet Site for Fostering Greater Female Employee Involvement in Workplaces

We launched the Try Net intranet site in January 2009 to change mindsets and create a corporate culture that encourages more female employee involvement in the workplace. All employees can contribute to this communications tool and obtain information on female worker promotions and work-life balance.



Improving Employee Morale and Skills

We continue to take steps to build an organization in which all employees can realize their potential and grow by gaining satisfaction from work.

Educating and Training Based on the Kyushu Electric Power Educational Charter

Based on the Kyushu Electric Power Educational Charter, our guideline for employee education, we establish an employee education policy every year for various programs to improve personal qualities, skills, and management capabilities and build a work climate that focuses on cultivating human resources.

Finding Work for Retirees

We launched our Senior Employee System in FY2007, to offer work that accommodates more diverse employment needs and to draw on the skills and motivations of individual retirees by gradually increasing the retirement age to 65.

Our broad support structure for retirees includes the Career Bank System, which outsources to retirees who prefer that option, the Reemployment Support Course for those seeking jobs elsewhere and the Leave System for Early Career Changes.

Hiring the Physically and Mentally Challenged

We are promoting employment of disabled people so they can enjoy normal lives and work in society. Special-purpose subsidiary, Kyushu Captioning Co-Production Center Inc. is expanding occupational fields for such workers while reducing information barriers by providing close-captioning services for television broadcasts.

Our employment of disabled people has thus exceeded the legally required rate of 1.8% in recent years.

▼ Number of physically and mentally challenged people and percentage of all employees

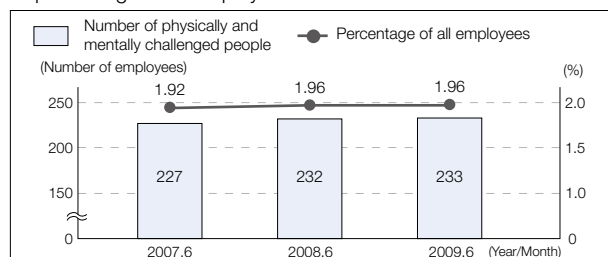

We also provide joint training and share relevant facilities to boost overall Group capabilities.

Rebuilding Comprehensive Personnel Affairs and Labor System

To provide job satisfaction and growth for employees, we are establishing clear standards for employee attitudes and abilities. We are thus comprehensively rebuilding our personnel affairs and labor systems, including those for employment, education, training, transfers, allocations, assessments, and treatment.



Intranet
Work-life balance

Special-purpose subsidiary

Maintaining Our Safety-First Principle

The top priority in all our business activities is to ensure safety for society and employees by constantly endeavoring to improve our facilities and technologies.

Ensuring Nuclear Power Safety

Nuclear Power Station Safety Framework

We maintain multilevel safety measures to prevent nuclear power station accidents, such as accidental releases of radioactive substances.

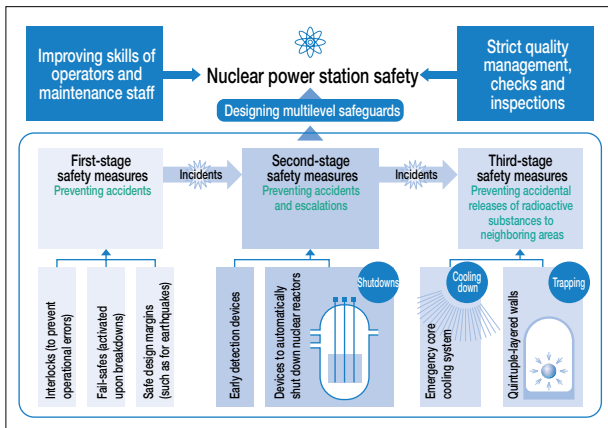

● Results of Seismic Assessments at Nuclear Power Stations

We implemented assessments based on new aseismic guidelines in keeping with a September 2006 revision of the Regulatory Guide for Reviewing Seismic Design of Nuclear Power Reactor Facilities.

We also systematically evaluated seismic safety at existing nuclear power stations in light of knowledge we gained as a result of the Chuetsu-oki Earthquake in Niigata Prefecture.

We thus confirmed the seismic safety of our facilities and submitted a final report to the Ministry of Economy, Trade and Industry.

A government committee or organization will verify the report.

Report Outline

1. We implemented geological surveys. Based on the assessment methods of the new earthquake guidelines and knowledge gained from the latest literature, we evaluated active faults that we need to consider for aseismic design.
2. Based on assessments in the new earthquake guidelines and knowledge gained from the Chuetsu-oki Earthquake in Niigata Prefecture, we laid down a standard ground motion Ss (for a peak ground acceleration of 540 Gal for both the Genkai and Sendai nuclear power stations).
3. We confirmed the aseismic safety of critical buildings and structures, equipment, and piping systems at the Genkai and Sendai nuclear power stations after factoring in the new earthquake guidelines and other considerations.

Maintaining Nuclear Power Facilities

● Inspecting and Repairing Facilities in Line with Maintenance Management Rules

To ensure the safety and reliability of our nuclear power stations, we maintain and manage facilities and equipment in keeping with statutory and private-sector inspection and repair standards.



Regular inspection

● Managing Environmental Radiation

We constantly monitor radiation levels outside our nuclear power stations and disclose real-time data on our Japanese website. We regularly measure the radioactivity of samples of soil, seawater and agricultural and marine products. We have found no environmental effect from our facilities.

The annual dosage to people living around our nuclear power stations is less than 0.001 mSv. This is well below the legal maximum of 1 mSv per year and the Nuclear Safety Commission's target of 0.05 mSv annually.

▼ Website disclosing dosage data (image shows the layout at Genkai Nuclear Power Station)





Please explain your initiatives to ensure the safety of nuclear power stations.

At our nuclear power stations, we undertake safety measures based on the concept of multiple protection and are developing emergency disaster preparedness initiatives.



Preventing Nuclear Disasters

● Firefighting Preparedness

We maintain 10-person firefighting units at our nuclear power stations. Five of those firefighters are on duty around-the-clock, with another five ready to participate in any emergency work. Each facility has a chemical fire engine and a water truck with a portable motor pump.

Nuclear Disaster Drills

Our nuclear power stations maintain rigorous safety measures to respond swiftly to disasters. As part of ongoing efforts to ensure preparedness, we maintain contingency response plans with national and local government bodies in line with the Special Law of Emergency Preparedness for Nuclear Disasters and the Disaster Countermeasures Basic Act.

We participate in annual nuclear disaster drills in Saga and Kagoshima prefectures. We conduct drills for issuing bulletins and for monitoring the environment during emergencies.



Maintaining Occupational Safety and Health

Eliminating Occupational Accidents

While upholding our safety-first principle and striving to eradicate accidents resulting in death or serious injury or harming customers, we are reviewing our safety promotion and management systems and are deploying Worker Health and Safety management systems.

We have reinforced educational and training programs with training that includes virtual exposure to dangers to improve worker attitudes and behavior and thereby prevent accidents caused by human error. We rigorously implement such practices as risk prediction and use pointing and calling to avoid mistakes.

▼ Number of Occupational Accidents by Category

	FY2005	FY2006	FY2007	FY2008	FY2009
Electric shocks	1	1	2	2	4
Traffic accidents	10	7	12	5	9
Falls	2	0	0	0	0
Others	19	16	29	17	23
Totals	32	24	43	24	36

Note: The Others category includes falls from failing to check footing and mishandling of tools.

Ensuring Mental and Physical Well-Being and Comfort

We create workplaces that minimize fatigue and stress, and maintain numerous programs to safeguard employees, complementing traditional measures for disease prevention. The programs include helping employees build healthy bodies, notably by providing health guidance and offering mental health care. We also deploy initiatives to prevent illness from overwork, prevent eyesight damage from visual display terminal usage and shield against passive smoking.

Overview of Mental Health Initiatives

Level 1 Prevention	<ul style="list-style-type: none"> Educate and enlighten (instruct on recognizing and addressing stress, and identifying and assisting others under stress) Measure occupational stress and build frameworks to improve working environments
Level 2 Early detection, and response and alleviation	<ul style="list-style-type: none"> Create a climate in which employees can identify when they experience stress (through interviews to assess health and simple occupational stress diagnoses) Make it easy for employees to seek help (through occupational therapists, mental health medical counselors and external consultancies) Encourage health nurses and industrial doctors to follow up with sufferers of stress to quickly identify and treat their problems
Level 3 Helping employees to return to work	<ul style="list-style-type: none"> Provide support during treatment (liaise with doctor in charge, families and supervisors and regularly communicate with sufferers) Assist employees when they return to work (initially shortening working hours, then prohibiting overtime and business trips) Provide work site support (liaise with supervisors and follow up with industrial physicians and health nurses)

Preventing Electric Shocks in Public

We hold three publicity campaigns annually to help reduce the number of electric shock incidents. During Power Safety Month, we highlight this issue to engineering and construction firms, crane companies, educational institutions, municipalities and other organizations, and conduct public relations campaigns and solicit cooperation.

We install reminder signs at river intersections and other key locations to prevent electric shocks from cranes and other heavy machinery or fishing rods touching power lines.

▼ Number of Public Electric Shock Incidents

	FY2005	FY2006	FY2007	FY2008	FY2009
Number	2	0	1	0	0



Community Contributions

We seek to act as a good corporate citizen by collaborating with the communities we serve and by contributing to society at large by promoting comfortable living and sustainable development.

Deploying Social Initiatives that Reflect Community Feedback

In keeping with our Basic Policy for Coexisting with Communities and Society, we undertake initiatives around Kyushu to help build attractive communities and foster the young.

We gather and reflect feedback from communities on our policies and activities to improve our efforts. We set up quantitative targets in our CSR Action Plan to enhance customer satisfaction and strive to resolving community issues with residents.

Quantitative Targets for FY2010 Kyushu Electric Power Group CSR Action Plan

The following presents residential customers' rates of satisfaction based on two survey questions:

1. Local economic and cultural contributions

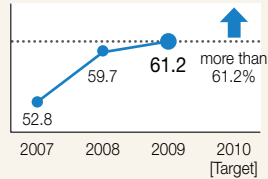

2. Collaboration in local activities

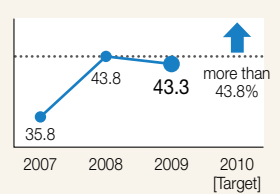

(We based our targets on the highest positive responses received.)

Note 1: Q1. Does Kyushu Electric Power help invigorate the local economy and culture?
Q2. Does Kyushu Electric Power actively participate in local activities, events, and volunteer activities?

Note 2: Degree of satisfaction: On a scale of 1 to 5, proportions of people responding with 1 (I think so) or 2 (I basically think so).

Initiatives to Enhance Regional Attractiveness

● Participating in Local Festivals

As a part of efforts to preserve local culture and to deepen ties with local communities, employees of each business site and Group company participate in and/or manage local festivals.



Nagasaki Peiron Championship
(Nagasaki Branch)

● Supporting Traditional Craftsmanship

We help maintain and preserve traditional crafts in Kyushu and promote the traditional craft industry and production areas that are so valuable for Kyushu.



Traditional crafts exhibition and pottery class
(Kitakyushu Branch)

● Ocha-no-ma Essay Contest

Through joint sponsorship between branches and local newspapers, we solicit essays on various themes relating to people's experiences and events.



Essay collection
(Saga Branch)

● Revitalizing Local Areas and Supporting their Industries

We undertake activities to help revitalize local communities, including by holding symposiums with municipalities on community development and arranging exhibitions of local products and industries.



Community development symposium in Minamata
(Kumamoto Branch)

● Supporting Sports

We support local tournaments for everyone from children to senior citizens, to enhance community enjoyment and health and also to popularize and improve sport standards around the region.

Rugby is Kyushu Electric Power's symbolic sport. Our rugby team continues to invigorate local sport by coaching local boys' rugby teams and participating in events.



Boys' softball tournament
(Fukuoka Branch)



Rugby clinic in Oita City



What children's events or other efforts are you making to foster the young?



We set up the Kyushu Electric School of the Future, which offers an exciting curriculum for students.

Fostering The Young

Kyushu Electric School of the Future for the Young

We provide children around Kyushu with opportunities to learn and gain experience and interest in energy, the environment, culture, art and other subjects.

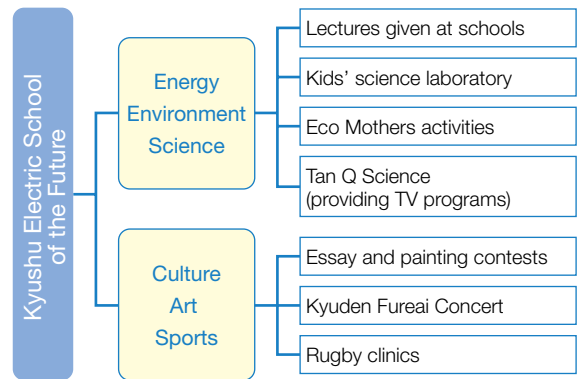

● Lectures given at schools



We visit schools around Kyushu to hold classes that deepen understanding of energy and environmental issues.

Classes in FY2009
497 classes
18,484 participants

Visits to schools to hold classes (Miyazaki Branch office)

● Painting contest (Kagoshima Branch)



In FY2009, we received a record 10,317 entries to our 18th annual painting contest.

We chose 500 winners and exhibited their works at the Kagoshima City Museum of Art and at other locations.

Kyushu Power Academy Established

We launched the Kyushu Power Academy in June 2009 to built a network of people at universities, technical colleges, and companies around Kyushu, and to cultivate technicians and researchers in electrical engineering in Kyushu and around Asia, and contribute to industrial and academic progress.



First general assembly of Kyushu Power Academy on December 10, 2009

Initiatives through Business Activities

HIGHLIGHT

Harnessing Convenient Electricity in Agricultural Technologies

The Research Laboratory's Bioresources research center is conducting agricultural productivity improvement studies, such as heat pump applications, and the use of lights, cultivation environment modifications, automated cultivation, and nutriculture technologies. It also explores technologies to keep agricultural products fresh and otherwise support agricultural progress in Kyushu.



Heat pump in orchid greenhouse



Heat pump

Business Overview

Kyushu Electric Power will always endeavor to properly deliver electric power and energy to its customers. By providing services that improve society and enhance quality of life, we contribute to building a comfortable, environmentally friendly and sustainable society.

Electric Power Business

Our mission and prime social responsibility in the electric power business is to provide safe, dependable and efficient supplies of electricity to our customers. To this end, we accommodate trends in electricity demand through efficient use of our facilities, while taking steps to reduce outages, optimally operating and managing those facilities and swiftly restoring power after disasters. These efforts have enabled us to raise our supply reliability standards while continuing to ensure universal service.

Looking Ahead to Ensure Stable Power Supplies

Promoting Nuclear Power and Introducing Renewable Energy

Japan can only obtain 4% (or 19% if including nuclear power) of the self-sufficiency of energy supply. Because the nation imports most energy resources, global developments greatly affect its energy supplies. So, it is extremely important to maintain energy security.

Reducing CO₂ and other greenhouse gas emissions is a pressing and ongoing challenge for combating global warming.

While positioning and promoting nuclear power as a core power source, Kyushu Electric Power is deploying such renewables as solar and wind power to stabilize its energy supplies over the long term and contribute to the national government's goal of a low-carbon society (see Focus 1 for details).

▼ Power source diversification plans (including power sourced from other companies)

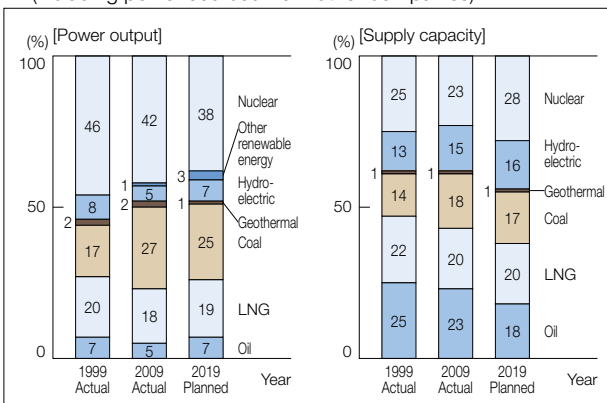

Building Facilities to Ensure Long-Term Stability and Efficiency

● High-Efficiency Thermal Power Generation

To ensure stable, long-term fuel supplies, we diversified our thermal power generation resources to include liquid natural gas and coal. At the same time, we are improving thermal power generation efficiency to lower CO₂ emissions and harness energy more effectively.

Specific efforts

- Replacing turbines at No. 1 unit of Shin Oita Power Station
- Developing 400,000-kilowatt turbines for No. 3 unit of Shin Oita Power Station

▼ Comprehensive thermal efficiency trends

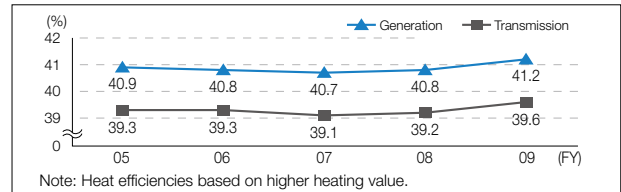

● Steadily Developing Omarugawa Power Station

Our pumped storage power stations accommodate peak demand and emergencies, as they offer excellent load following and speedy startups and shutdowns. The Omarugawa Power Station operates two units. We will continue developing this facility to start operating four 300,000-kilowatt units by FY2011, boosting maximum capacity to 1.2 million kilowatts.

● Building Robust and Simple Transmission Lines to Prevent Large Outages

We build efficient facilities from a long-term perspective, comprehensively taking into account such factors as demand trends, supply reliability from customer perspectives, safety, operational aspects of facilities and costs.

We ensure that facilities do not suffer outages because of normally foreseeable accidents or breakdowns. Our long-term goal is to build a trunk transmission system that will not succumb to large outages, even in the event of a natural disaster. We are constructing a 500 kV trunk line in Kitakyushu with the understanding and collaboration of stakeholders. We plan to construct a 500 kV trunk line in Hyuga (between Oita and Miyazaki).



Providing High-Value-Added Services that Balance Comfort and Environmental Concerns

Efforts to Maintain Reliable Supplies

The emergence of a society that increasingly relies on ubiquitous, advanced information and all-electric housing has made customer needs more diverse and sophisticated. It is even more important to stably supply high-quality electricity. We thus daily patrol our facilities, conduct inspections and repairs, maintain safe and efficient operations, and routinely develop and improve engineering techniques.

● Preventing Outages

We prevent transmission and distribution line outages by stepping up patrols and countermeasures to identify risks and stop birds and other wildlife from nesting in our facilities. We constantly survey distances between power lines and other objects and trim trees to prevent outages and facility damage, first obtaining the understanding and cooperation of relevant parties.

Responding to Major Disasters

We initiate our emergency management structure in response to predictions or occurrences of typhoons, earthquakes and other disasters. We keep in close contact with affiliates, business partners and government bodies in such circumstances so we can swiftly restore services.

Every July before typhoon season in Kyushu, we conduct emergency drills for large-scale disasters. These drills focus on:

1. Confirming roles under the command system
2. Quickly assessing disaster conditions and formulating and implementing restoration initiatives
3. Quickly supplying accurate information in-house and to external bodies
4. Swiftly and accurately responding to customers

We have drawn on our disaster experiences to improve systems in which large helicopters of the Self-Defence Forces can quickly carry generator trucks and other special vehicles to sites lacking power. We will continue to hold joint drills with the Self-Defence Forces so we can swiftly restore services to areas without power because of typhoons, earthquakes and other disasters.

▼ Main supply facilities (as of March 31, 2010)

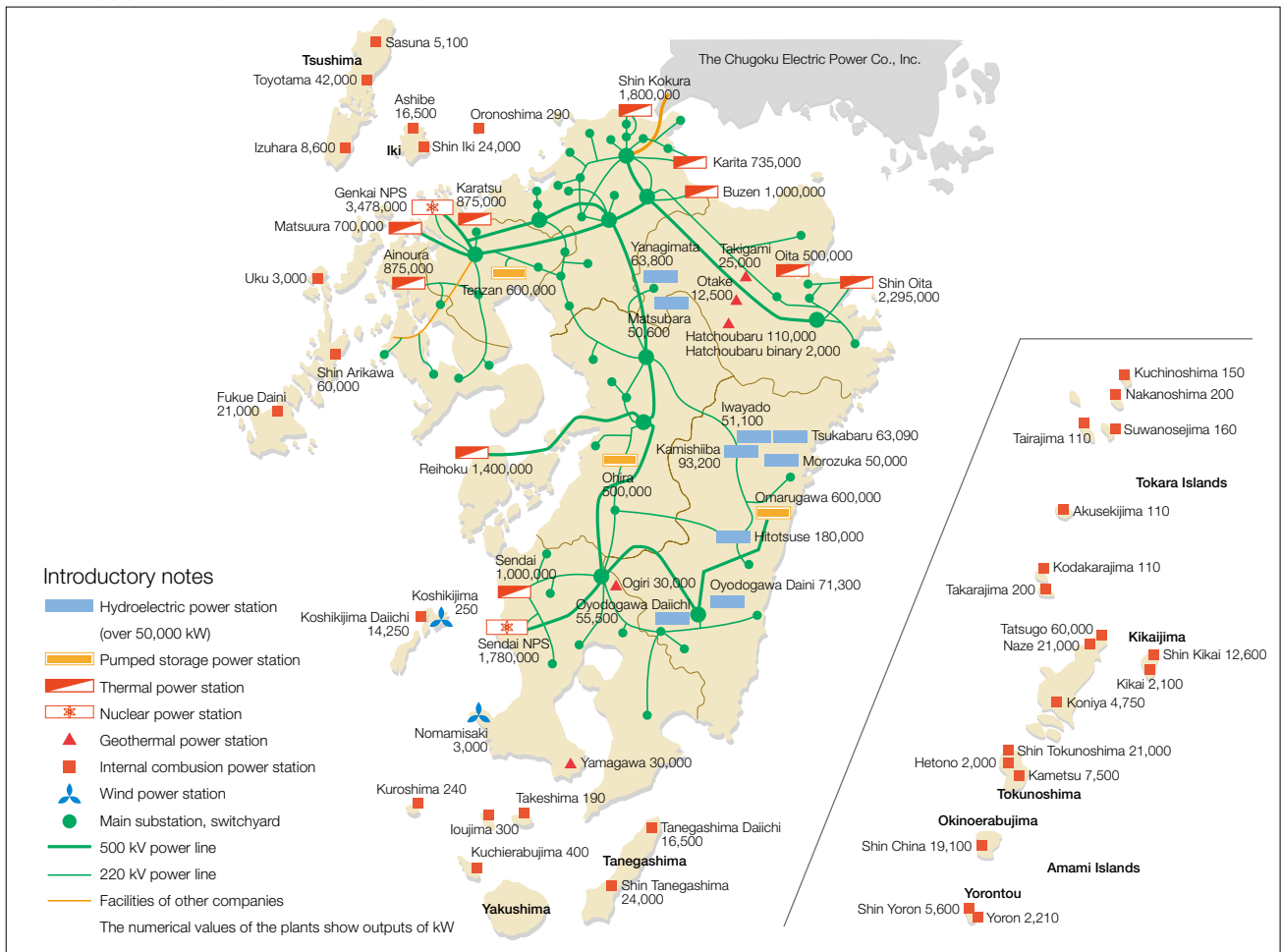

Ubiquitous society
Binary

Pumped storage generation

Developing and Supplying Services to Meet Customer Needs

● Better Interaction with Customers

We take every opportunity to gather customers' feedback and learn about their needs through roundtable talks, visits, and other means. We deliver optimal services that draw on information technology and other advanced tools.

● Planned Introduction of New Power Meters

We began deploying low-voltage electric meters with telecommunications capabilities in November 2009 to improve customer services and streamline operations. We will continue to systematically deploy this product.

After low-voltage electric meters come into common use, we will eventually be able to provide power usage status data, propose energy-saving and comfortable living through consultations, restore service more swiftly by identifying low-voltage outage

▼ Deploying optimal services

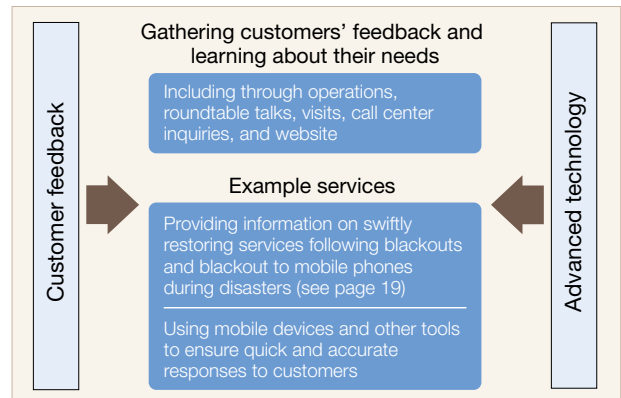

areas, and handle meter operations efficiently by remote control.

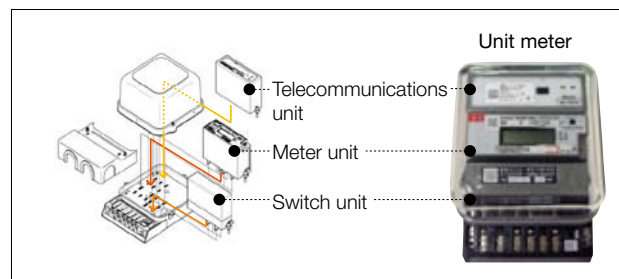

▼ Image of low-voltage electric meters come into common use

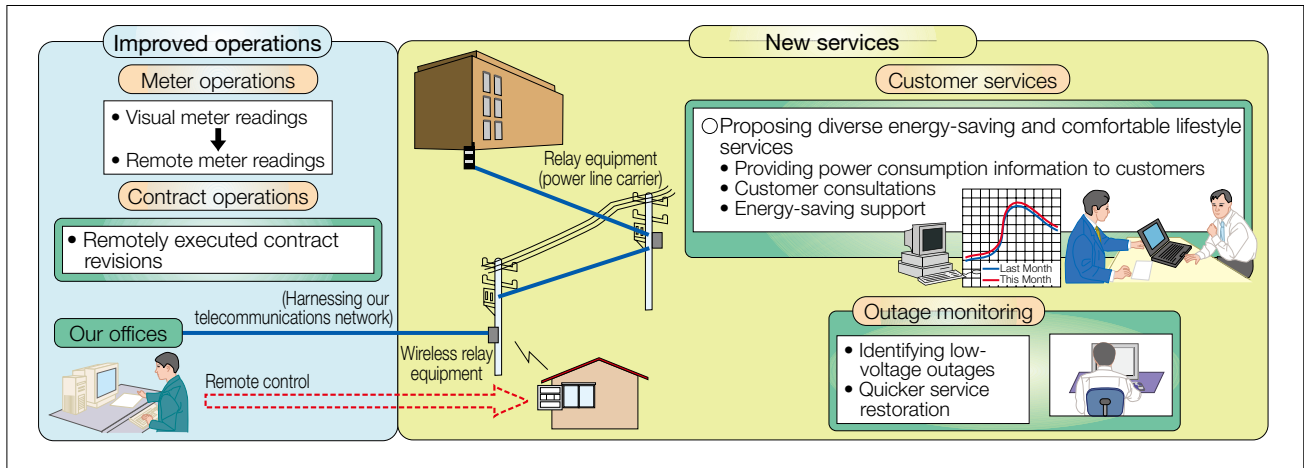

● Initiatives to Popularize Electric Vehicles

We are developing rapid chargers and other equipment to build the infrastructure essential for popularizing electric vehicles.

We began developing and conducting tests of a rapid charger in FY2006, and started selling this product through Group company Kyuki Corporation in September 2009. We made the charger compact and incorporated a personal ID card capability to improve convenience.

We will continue striving to improve user convenience and lower the cost to help popularize electric vehicles.

* It takes around 30 minutes to attain an 80% charge with an i-MiEV (and about 14 hours to fully charge at 100 volts).



Electric vehicle at a rapid recharging stand

Providing Services to Help Customers Improve Energy Efficiency

● Energy Savings and Comfortable Living

In keeping with greater concerns about global environmental issues, natural resources and energy issues, we collaborate with customers in exploring lifestyles that are comfortable and use energy efficiently.

● Comprehensive Energy Proposals

Account managers at each customer service office help us to better address the issues and needs of corporate customers. The managers draw on Group resources to handle comprehensive energy requests and counseling needs, create fee proposals that reflect power consumption, and consult on electric kitchens, electrical air-conditioning and other energy-saving ideas.

Specific initiatives

- Proactive publicity on saving energy, such as introducing "using power skillfully," by home advisors and staff members from Iris.
- Promoting all-electric housing centered around energy-efficient Eco Cute equipment.

FY2010 energy-saving goal

Cut CO₂ emissions by 90,000 metric tons annually

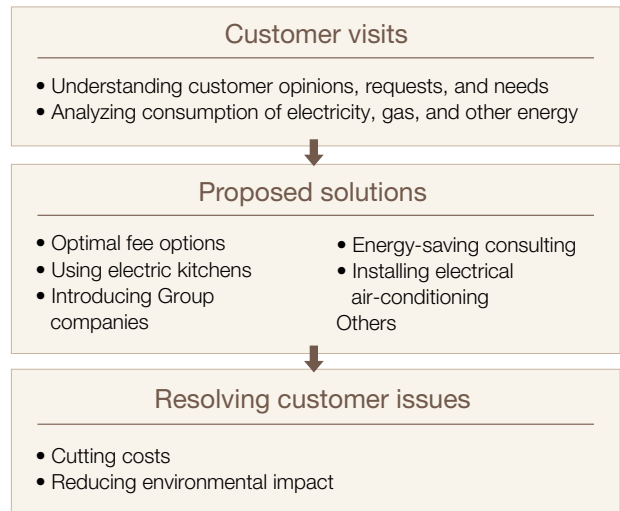

Energy-Related Business

Onsite Solar Power Generation —Kyuden Ecosol Co., Ltd.— <http://www.q-ecosol.co.jp>

To help promote and expand the use of renewable energy in Kyushu, in December 2009 we established Kyuden Ecosol Co., Ltd. This onsite solar power business targets industrial and public sector customers.

Kyuden Ecosol's one-stop offerings range from design to maintenance and management. It installs solar power generation equipment at factories, buildings, and other facilities to supply customers with power.

To date, Kyuden Ecosol has provided high-quality, low-cost services to customers, promoting its business by harnessing Group strengths, including technologies from electric power business. Kyuden Ecosol aims to help popularize solar power generation in Kyushu.

Onsite power generation framework

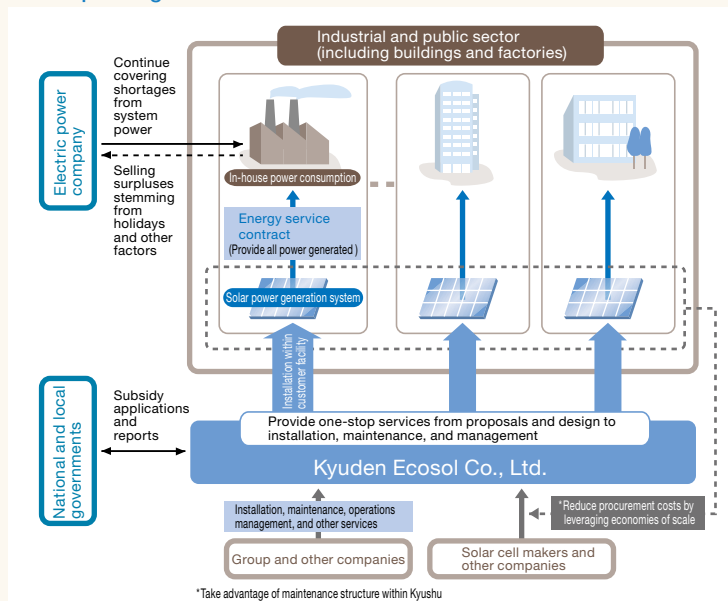

- Customer benefits of onsite power generation**
1. No initial investment necessary for solar power equipment
 2. Customer does not have to deal with various application procedures when installing equipment
 3. Operational company takes care of all operations, including equipment maintenance and operations

Overseas Operations

The Group draws on expertise from its domestic electric power operations and personnel with advanced technological capabilities to build its overseas electric power businesses and consulting businesses, with particular focus on Asia. Consulting covers power source development, surveying and designing transmission and substation facilities, and energy savings and the environment.

In FY2009, we opened our first overseas office, in Singapore, to collect information and support overseas business projects.

Through these operations, we aim to provide stable supplies of electricity in Asia, where demand is soaring, while contributing to environmental measures, cultivating human resources and building new businesses.

▼Overseas power development efforts as of the end of March 2010

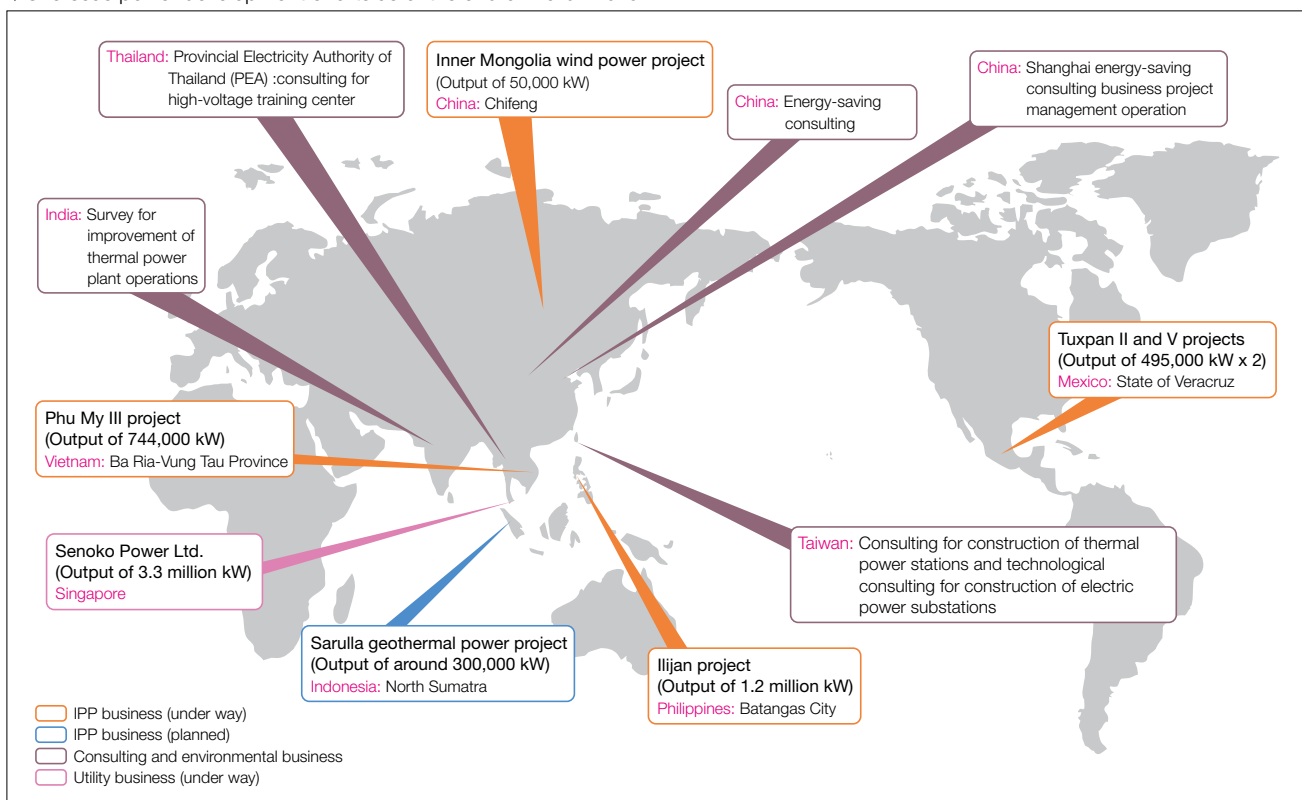

Opening of Singapore Office

In July 2009, we opened our first overseas office in Singapore, to collect information on cultivating business activities, mainly in Indonesia, Vietnam, the Philippines, India, and other areas around Asia that complement Kyushu's geographical location. The office also supports overseas business projects.

We plan to use this office as a foothold for expanding our business by taking advantage of our technologies and expertise, collecting information on new projects and managing existing ones.



Inside Singapore office



President Toshio Manabe speaking at opening ceremony

Financial Highlights

Overview of FY2009 Results

Overview of Consolidated Results

In FY2009, total operating revenues dropped 5.2% year on year, to ¥1,444.9 billion. Total ordinary revenues declined 5.1%, to ¥1,456.2 billion. These decreased reflected lower electricity sales volume and a decrease in unit charges in the electric power business owing to lower fuel costs.

Total ordinary expenses were down 6.4% to ¥1,388.6 billion, owing to the lower fuel costs and decreased electricity sales volume.

Ordinary income thus increased 34.0%, to ¥67.6 billion. Net income rose 23.0%, to ¥41.8 billion.

▼ Consolidated Statements of Income (Billions of yen, %)

	FY2009	FY2008	Change	Percentage change
Total operating revenues	1,444.9	1,524.1	-79.2	94.8
Other revenues	11.3	10.4	0.9	108.9
Total ordinary revenues	1,456.2	1,534.6	-78.3	94.9
Total operating expenses	1,345.2	1,439.4	-94.2	93.5
Other expenses	43.4	44.6	-1.2	97.3
Total ordinary expenses	1,388.6	1,484.1	-95.4	93.6
Operating income	(99.7)	(84.7)	(15.0)	(117.7)
Ordinary income	67.6	50.4	17.1	134.0
Extraordinary profit	—	5.4	-5.4	—
Income taxes	25.4	21.4	3.9	118.3
Minority interests in net income of consolidated subsidiaries	0.3	0.3	—	101.7
Net income	41.8	33.9	7.8	123.0

Management Efficiency

We strove to boost overall operational efficiency while implementing initiatives to reduce society's carbon footprint and maintain supply reliability. Efforts included investing capital more efficiently by reviewing construction timing and the scopes of measures. We also assessed the efficiency of repair costs by reviewing facility inspections and repairs and improved work productivity by using information and communications technologies in operational process reforms.

▼ Capital investment

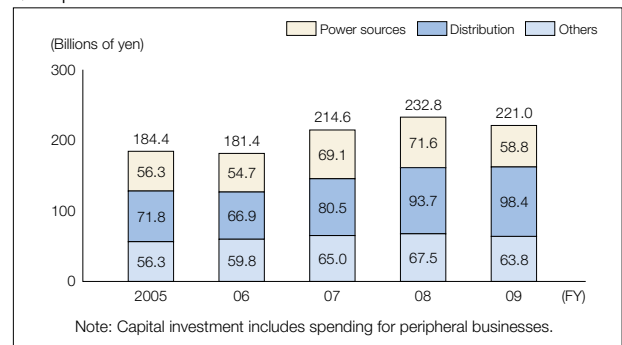

▼ Maintenance and miscellaneous costs

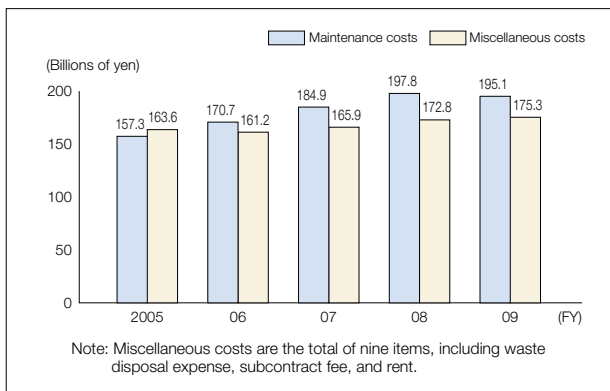

▼ Number of employees

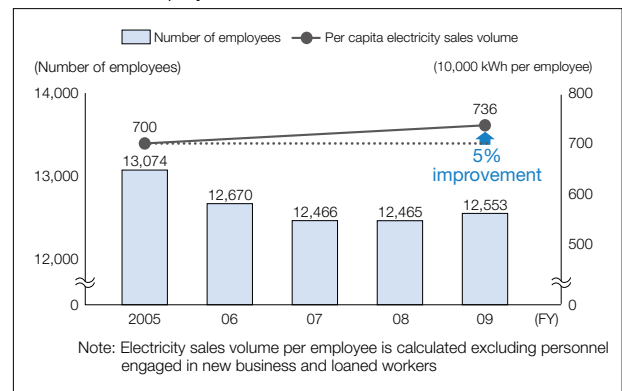

Third-Party Assessments

Fumiko Takayama,

Director of Library and Information Center,
Oki Town, Fukuoka Prefecture, Former
Deputy Mayor of Oki Town, Mizuma District,
Fukuoka Prefecture, Former Director of
Fukuoka Prefectural Gender Equality Center,
and Former Part-time Instructor
at Chikushi Jogakuen University



It is naturally important for a CSR report to present proper content. At the same time, it may be more important to show a stance that conveys its sense of corporate social responsibility to readers. So, I noticed improvements from that perspective. I saw efforts in many areas of the report to make it easier to read, notably with larger photos and graphs, and there were more graphs than in last year's report.

Overall Structure of Report

The Focus 1 section of the previous CSR report focused on the topic of Ensuring Eternally Stable Supplies of Environmentally Friendly Energy. For this year's report, the company presented a different viewpoint in a section titled, Toward a Low-Carbon Society. In Focus 2 this year, it discussed its safety-first policy, focusing on the high number of accidents last year.

I laud the attempt to alter the structure and contents of the report in line with changes in social issues and immediate challenges for Kyushu Electric Power.

The report also outlines businesses in more detail than the previous one. It also presented its stance on corporate governance, CSR management, and compliance management, and conveyed to readers the weight of corporate management responsibilities.

Nuclear Power Safety

Kyushu Electric Power prioritizes safety in generating nuclear power, the top issue for stakeholders. The company describes its framework for ensuring the safety of nuclear power plants, using a flow chart on page 10 and provides a detailed description in the Safety-First Principle section on page 25. The subject will require full explanations. The company's pluthermal power generation program has attracted a lot of attention as a pioneering effort, but it also presents many safety concerns. I hope that the company takes every opportunity to provide information.

Global Warming Measures

I believe that electric power companies play a major role in tackling global warming, a high-profile issue. In that regard, I believe that Kyushu Electric Power's efforts to deploy renewable energy to combat global warming are convincing to readers. This approach is also evident in the new initiatives started in FY2010. See page 12 for Initiatives for Biomass Power Generation, which covers testing mixed power generation with wood biomass from timber offcuts and other unused forestry resources at the Reihoku Power Station in Kumamoto Prefecture.

Disclosure

Information on business activities is naturally important. But I think that stakeholders would be most interested in disaster and nuclear power information. Kyushu Electric Power therefore made a worthwhile effort on page 19 to show its preparedness to disseminate information during disasters and on page 20 where it presents information on nuclear power generation.

Promoting Work-Life Balance

The report presents work-life balance initiatives from the perspectives of gender equality and fostering the young. Only a few male employees took childcare leave or worked shorter hours, as shown on page 23. I hope to see more powerful initiatives. So, I look forward to seeing the results of new initiatives introduced on page 23, including those started in FY2009. They include including childcare leave periods in years of service for the company and increasing the number of days for maternity leave. Initiatives started in FY2010 included a revised number of days for nursing care leave and a new family care leave program.

Community Contributions

As a corporate citizen, it is a company's responsibility to contribute to communities itself and through its employees. I thus rate Kyushu Electric Power highly for its meticulous support for volunteerism, including through its leave system, subsidies for activities and gaining qualifications, and providing information. More and more people today talk about new public roles. I expect much from Kyushu Electric Power in that regard and look for it to further expand and deploy social contribution initiatives.

The report shows overall that Kyushu Electric Power is steadily cultivating diverse CSR activities. I hope the company will strengthen its framework for soliciting and responding to feedback on a daily basis.

Response to Third-Party Assessments



Yasumichi Hinago,
Director in charge of CSR
Executive Vice President
Kyushu Electric Power Co., Inc.

Kyushu Electric Power asks third parties to assess its CSR report and post their opinions to ensure the objectivity and enhance the credibility of that publication.

Kunihiko Furuya,
 Professor
 Faculty of Law
 Graduate School of Law
 Kyushu International University



This year's CSR report was Kyushu Electric Power's fifth. It newly presented what the company deems its most important CSR issues in the Focus sections. I think that demonstrates the company's sensitivity to what society demands of it as a leading company in choosing to spotlight creating a low-carbon society and safety. It is very timely that the company is focusing on such renewable energy as nuclear, wind, and solar power to minimize CO₂ emissions. I was impressed as a reader with the company's stance on tackling issues to harness such energy. I was also impressed that the company described safety problems in nuclear power generation, a prime concern for people, recording details of accidents. In future reports, I would like Kyushu Electric Power to mention about solar power initiatives for individual homes, which most consumers would be more familiar with.

I considered the following points important in this report.

CSR Implementation Based on a Clear Management Philosophy

In the opening message on pages 3 and 4, President Toshio Manabe listed three key points. The first was about environmentally friendly energy initiatives. The second was about building a sustainable society. The third was about job satisfaction. The report elaborated on these points, in simple prose, in the management philosophy section of pages 5 and 6. Each section explains specific initiatives. Such a consistent structure made the report easy to understand Kyushu Electric Power's overall CSR goals.

We again solicited an evaluation from Director Fumiko Takayama of the Library and Information Center in Oki Town, Fukuoka Prefecture. At the same time, we asked Professor Kunihiko Furuya of the Faculty of Law at Kyushu International University for his views. Both parties made objective analyses and provided thought-provoking points and suggestions.

As Director Takayama proposed, we will properly inform about nuclear power from the perspectives of customers and local residents while maintaining safety as our top issue. For community contributions, we will encourage greater volunteerism among employees, and will think and work with customers and communities, including with government and citizen's groups, by fulfilling our corporate citizenship role.

Professor Furuya mentioned that we should "mention about solar power initiatives for individual homes, which most consumers would be more familiar with." We will look into improving the content in next year's report to include our

Ensuring Transparency

In recent years, the key social demand of companies has been transparency. I believe that this report fulfilled that requirement. Kyushu Electric Power importantly clarified specific initiatives, particularly those concerning safety, corporate governance, compliance, disclosure, and respect for human rights throughout the report.

Compliance Management (page 17)

In the Compliance Management section, I felt that Kyushu Electric Power properly demonstrated its efforts, notably by establishing a Compliance Committee and an internal reporting system. Disclosing the number of consultations and reports, the contents, and number of information leaks (there were 30) was a significant transparency step.

Respecting Human Rights and Caring for Employees (page 23)

This section shows great deal of advanced care for the employees as a leading company, explaining detailed initiatives to promote work-life balance. The company also provided specific numbers concerning such issues as 1) its support for family care, 2) support for women's career development, and 3) its system for employing senior citizens. I laud highly the community care efforts that go beyond caring for existing employees, including providing jobs for people with disabilities. This fulfilled a social responsibility and, at a 1.9% rate, exceeded the legal minimum. I hope that people with disabilities will eventually account for 2.0% of the company's workforce, the legal requirement for public institutions and government offices.

measures in power transmission, transformer, and distribution facilities ahead of the massive deployment of solar power and other renewable energy sources. We will also cover initiatives to build next-generation power systems.

In terms of promoting work-life balance and creating work environments that successfully foster diversity, Kyushu Electric Power considers that supporting such diversity and satisfying and motivating employees will improve labor productivity and invigorate the entire organization. We will continue to push ahead with such initiatives to improve corporate value.

Based on the guidance from our third parties, we will continue to reinforce our involvement in CSR. The next report will present these efforts. We again look forward to feedback from stakeholders.

PR Facilities

Kyushu Energy Science Center

4-13-55, Yakuin, Chuo-ku, Fukuoka
 TEL: +81-92-522-2333
 • Opening hours 9:00am-5:00pm
 • Closed every Monday (if a national holiday falls on a Monday, then closed on the following day) and New Year holidays (December 29–January 2)



Genkai Energy Park

4112-1, Aza asako, Imamura, Genkai-cho, Higashimatsuura-gun, Saga
 TEL: +81-955-52-6409
 • Opening hours 9:00am-5:00pm
 • Closed every 3rd Monday of the month (if the 3rd Monday is a national holiday, then closed on the following day) and new year holidays (December 29–January 2)



Sendai Nuclear Power Station Exhibition Hall

1758-1, Aza kodaira, Gumisaki-cho, Satsumasendai, Kagoshima
 TEL: +81-996-27-3506
 • Opening hours 9:00am-5:00pm
 • Closed on New Year holidays (December 29–January 1)



Hacchoubaru Power Station Exhibition Hall

601, Aza hacchoubaru, Oaza yutsubo, Kokonoemachi, Kusu-gun, Oita
 TEL: +81-973-79-2853
 • Opening hours 9:00am-5:00pm
 • Closed on New Year holidays (December 29–January 3)



Yamagawa Power Station Exhibition Hall

2303, Yamagawaogawa, Ibusuki, Kagoshima
 TEL: +81-993-35-3326
 • Opening hours 9:00am-5:00pm
 • Closed on New Year holidays (December 29–January 3)



Nomamisaki Wind Park Exhibition Hall

16247-1, Kataura, Kasasa-cho, Minamisatsuma, Kagoshima
 TEL: +81-993-59-5522
 • Opening hours 9:00am-5:00pm
 • Closed on New Year holidays (December 29–January 3)



Tenzan Power Station Exhibition Hall

1327, Oaza amagawa, Kyuragi-machi, Karatsu, Saga
 TEL: +81-955-65-2266
 • Opening hours 10:00am-4:00pm
 • Closed on New Year holidays (December 29–January 3)
 The underground power plant cannot be seen on Saturdays, Sundays and national holidays.



Hitotsuse Power Station Visitor Center

509-12, Aza matoba, Oaza nakao, Saito, Miyazaki
 TEL: +81-985-24-2140
 (Miyazaki Branch Office, Public Relations Group)
 • Opening hours 9:00am-5:00pm
 • Closed every Monday and on New Year holidays (December 29–January 3)



Omarugawa Power Station Exhibition Hall—PinoQ Park

1246-14, Aza odaira, Oaza ishikawauchi, Oji, Kijocho, Koyugun, Miyazaki
 TEL: +81-983-39-1990
 • Opening hours 9:00am-5:00pm
 • Closed every Monday (if Monday is a national holiday, then closed on the following day), and on New Year holidays (December 29–January 3)



Kyuden Puratto Hall

1-1, Torioi-cho, Satsumasendai, Kagoshima
 TEL: +81-996-23-2131
 • Opening hours 9:00am-6:00pm
 • Closed on New Year holidays (December 29–January 1)



Iris Kitakyushu

River-walk Kitakyushu BLD 5F, 1-1-1, Muromachi, Kokurakita-ku, Kitakyushu
 TEL: +81-93-533-2074
 • Opening hours 10:00am-6:00pm
 • Closed on New Year holidays (December 31–January 3)

Iris Fukuoka

IMS BLD 6F, 1-7-11, Tenjin, Chuo-ku, Fukuoka
 TEL: +81-92-733-2090
 • Opening hours 10:00am-8:00pm
 • Closed every 3rd Tuesday (except for July, August and December) and on New Year holidays (December 31–January 1)

Iris Saga

2-3-6, Kouno-higashi, Saga
 TEL: +81-952-33-0800
 • Opening hours 9:00am-5:00pm
 • Closed every 3rd Sunday and on New Year holidays (December 29–January 3)

Iris Nagasaki

NK Iris BLD, 2-15 Douza-machi, Nagasaki
 TEL: +81-95-829-2990
 • Opening hours 10:00am-6:00pm
 • Closed every 3rd Tuesday and on New Year holidays (December 29–January 3)

Iris Oita

2-4-6, Kanaikemachi, Oita
 TEL: +81-97-534-2877
 • Opening hours 10:00am-6:00pm
 • Closed every 3rd Wednesday, and on New Year holidays (December 29–January 3)

Iris Kumamoto

Bipuresu Kumanichikaikan BLD 7F, 2-17, Kamitoricho, Kumamoto
 TEL: +81-96-326-1666
 • Opening hours 10:00am-6:00pm
 • Closed every 3rd Tuesday and on New Year holidays (December 29–January 3)

Iris Miyazaki

4-2-23, Tachibanadorinishi, Miyazaki
 TEL: +81-985-31-7075
 • Opening hours 9:00am-5:00pm
 • Closed every 3rd Sunday and on New Year holidays (December 29–January 3)

Iris Kagoshima

Kagoshima Shoko-Kaigisho BLD "Aimu" 2F, 1-38, Higashi Sengoku-cho, Kagoshima
 TEL: +81-99-224-6896
 • Opening hours 10:00am-6:00pm
 • Closed every 3rd Tuesday and on New Year holidays (December 29–January 3)

e-Kitchen Studio Fukuoka (commercial electric kitchen showroom)

4-2-8, Yakuin, Chuo-ku, Fukuoka
 TEL: +81-92-733-6509
 (Energy Support Group, Sales Department, Fukuoka Branch Office)
 • Opening hours 9:30am-5:00pm
 • Closed Saturday, Sunday and on national holidays



Harnessing Group Management Resources to Cultivate Businesses

Presenting Group Companies in Four Business Areas

Our energy-related businesses include the wholesale of electricity, constructing and maintaining equipment, supplying materials procurement, operations and providing energy, including renewable sources. We are also building diverse businesses that meet customer and local needs in the social and lifestyle

areas, encompassing IT and telecommunications, lifestyle-oriented services operations and environmental and recycling. We will continue to develop businesses that match the needs of customers and local communities by drawing on Group management resources.



Energy-Related Businesses



Facilities Construction and Maintenance

Kyushu Rinsan, Co. Inc.
Nishi nippon Plant Engineering and Construction Co., Ltd.
Kyuden Sangyo Co., Inc.
West Japan Engineering Consultants, Inc.
Kyudenko Co., Inc.
Nishikyushu Kyodo Kowan Co., Ltd.

Kyuken Corporation
Nishigi Kogyo Co., Inc.
Nihon FRP Co., Ltd.
Nishida Techno Service Co. Ltd.
NISHIGI SURVEYING AND DESIGN Co., Ltd.
Plazwire Co., Ltd.



Equipment and Materials Supply

KYUKI Corporation
NISHI NIPPON AIRLINES CO., LTD.
Kyushu Meter & Relay Engineering Corporation
KOYO Denki Kogyo Incorporated
Kyuhon Co., Ltd.
Kyushu Kouatsu Concrete Industries Co., Ltd.

CONTEX
SEISHIN CORPORATION
Nishinohon Denki Tekko Co. Ltd.
Japan-Australia Uranium Resource Development Co., Ltd.



Wholesale Electric Power and Energy

Tobata Co-operative Thermal Power Company Inc.
Oita Co-operative Thermal Power Co., Inc.
Kyuden International Corporation
Oita Liquefied Natural Gas Company Co., Inc.
KITAKYUSHU LIQUEFIED NATURAL GAS Co., Inc.
Nishinippon Environmental Energy Co., Inc.
Kyuden Ecosol Co., Inc.
Fukuoka Energy Service Co., Inc.

Miyazaki Biomass Recycle Co., Inc.
Nagashima Windhill Co., Ltd.
Amami Oshima Wind Power Co., Ltd.
Washiodake Wind Power Co., Ltd.
KYUSHU CRYOGENICS CO., LTD.
Kitakyushu LNG Lorry Sales
Fukuoka Clean Energy Co., Ltd.
Pacific Hope Shipping Limited
Kyuden Ilijan Holding Corporation
Phu My3. BOT Power Co., Ltd.

Electricidad Aguila de Tuxpan, S. de R.L. de C.V.
Electricidad Sol de Tuxpan, S. de R.L. de C.V.
Kyuden Sarulla PTE. LTD.
Sarulla Operation
Lion Power Holdings Pte Limited
Datang China-Japan (Chifeng) Corporation
Servicios de Negocio de Electricidad en Mexico, S. de R.L. de C.V.



IT and Telecommunications

Kyushu Telecommunication Network Co., Inc.
Kyuden Infocom Company, Inc.
NISHIMU ELECTRONICS INDUSTRIES, Co., Ltd.
Q-DEN BUSINESS SOLUTIONS Co., Inc.

RKK Computer Service Co., Inc.
Kagoshima Hikari Television Co., Inc.
RKKCS Software
COARA Co., Ltd.



Environment and Recycling Business

Kyushu Environmental Management Corporation
Japan Recycling Light Technology & System



Lifestyle-Oriented Services

DENKI BLDG. Co., Ltd.
Kyuden Good-Life Corporation
Kyuden Good Life Higashifukuoka Company, Inc.
Kyuden Good Life Kumamoto Company, Inc.
Kyuden Good Life Kagoshima Company, Inc.
Kyuden Good Life Fukuoka-Josui Corporation
Kyuden Real Estate Co., Ltd.

Kyuden Office Partner Co., Inc.
Kyuden Business Front Inc.
Kyushu Housing Guarantee Corporation
Kyuden HOME SECURITY Co., Inc.
Kyuden Shared Business Co., Ltd.
Kyushu Captioning Co-Production Center Inc.
Oak Ltd.

Kyushu Kougen Kaihatsu
Ito Golf Club
Fukuoka Shintoshin Kaihatsu
Midorigaoka Living Support
Capital Kyuden Corporation

